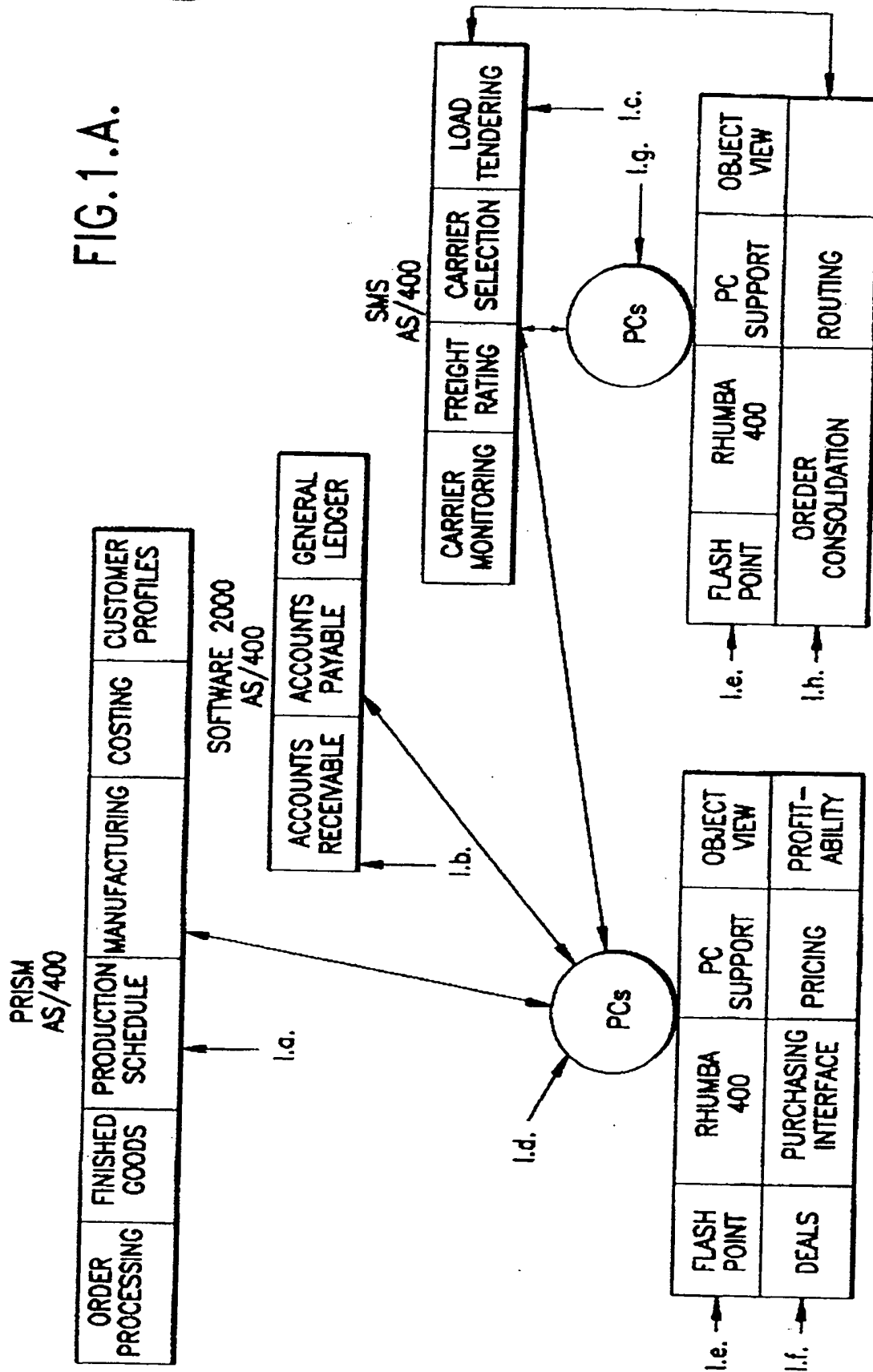

FIG. 1

FIG. 1.A.



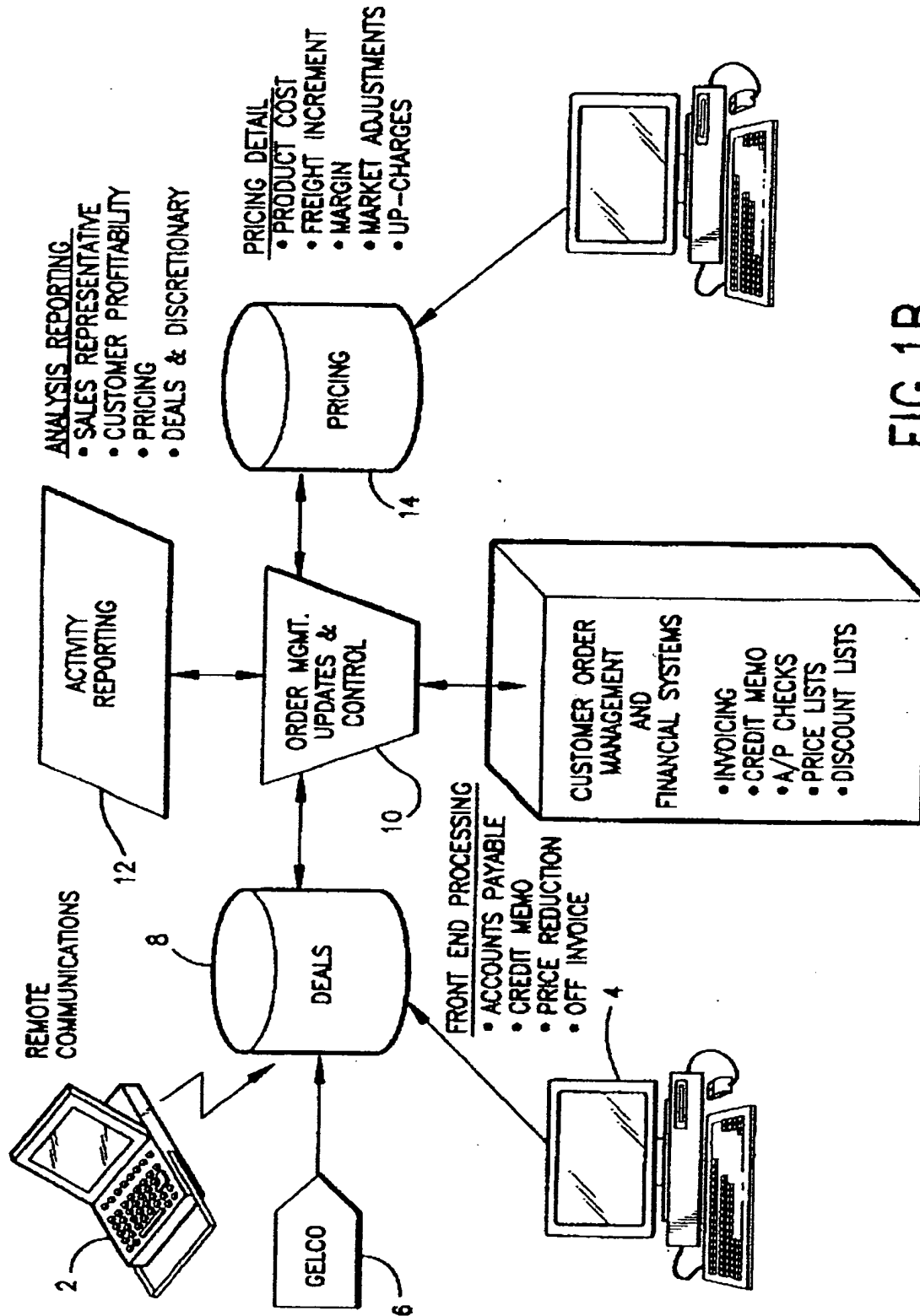

FIG. 1B

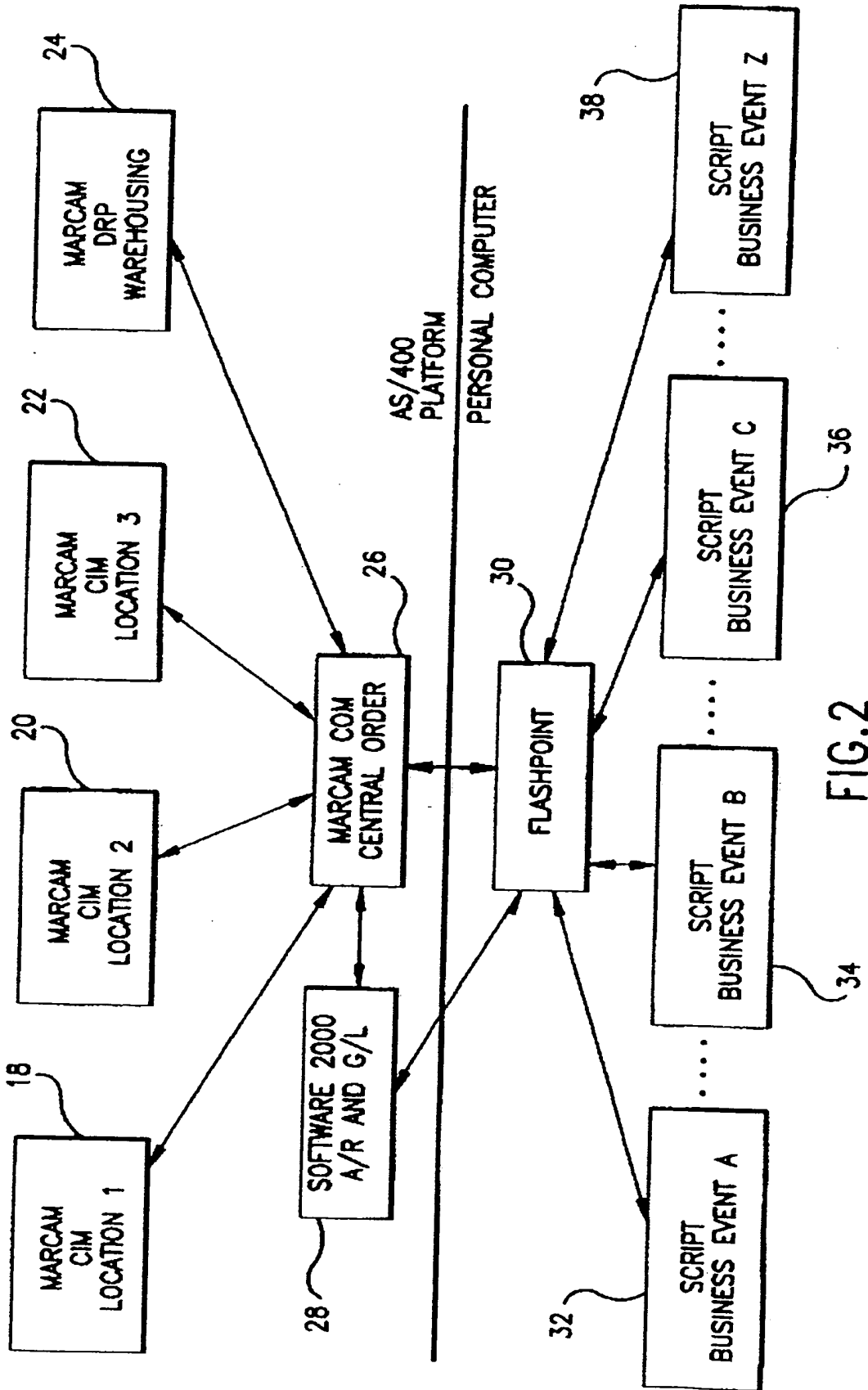

FIG.2

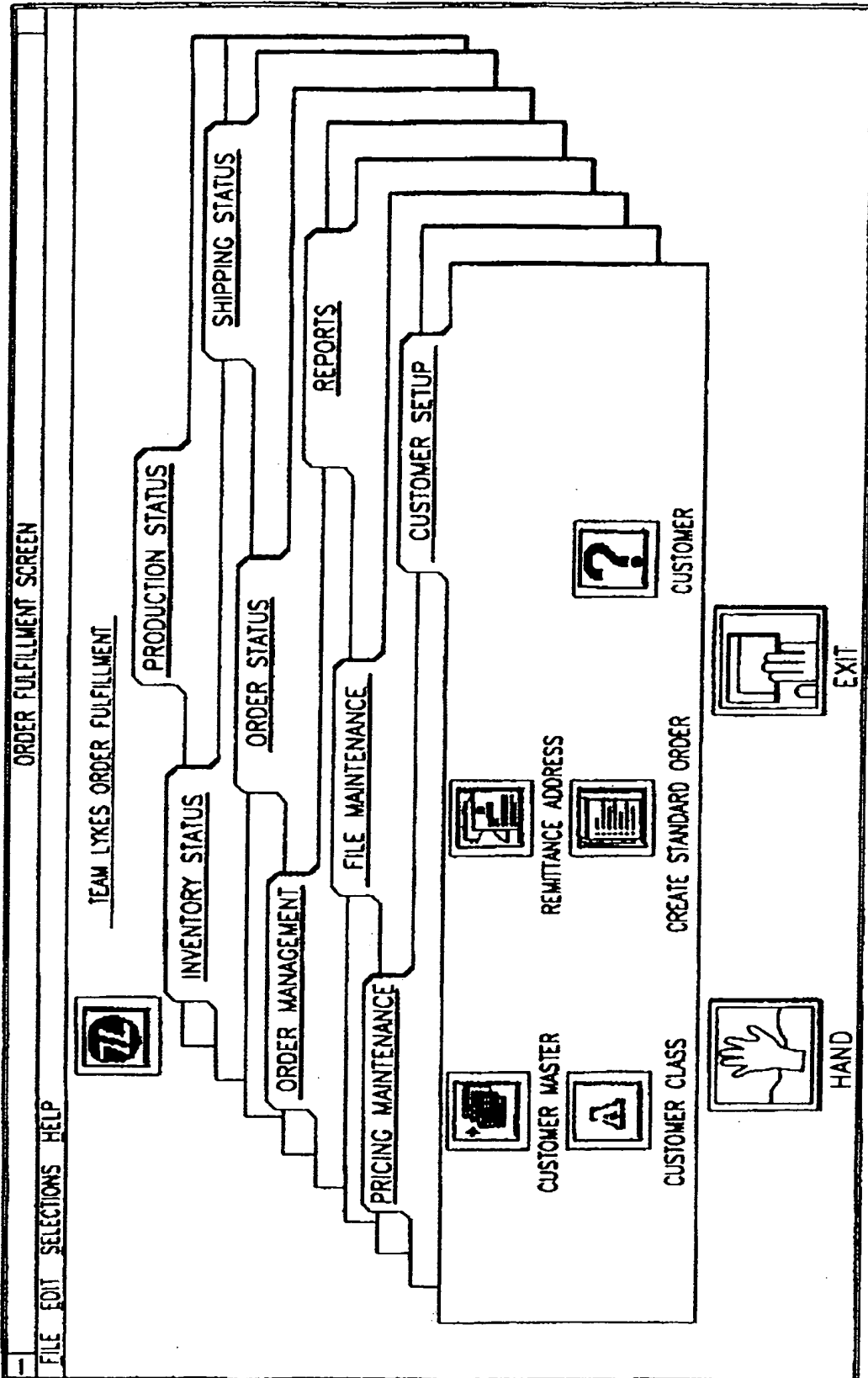

FIG.3

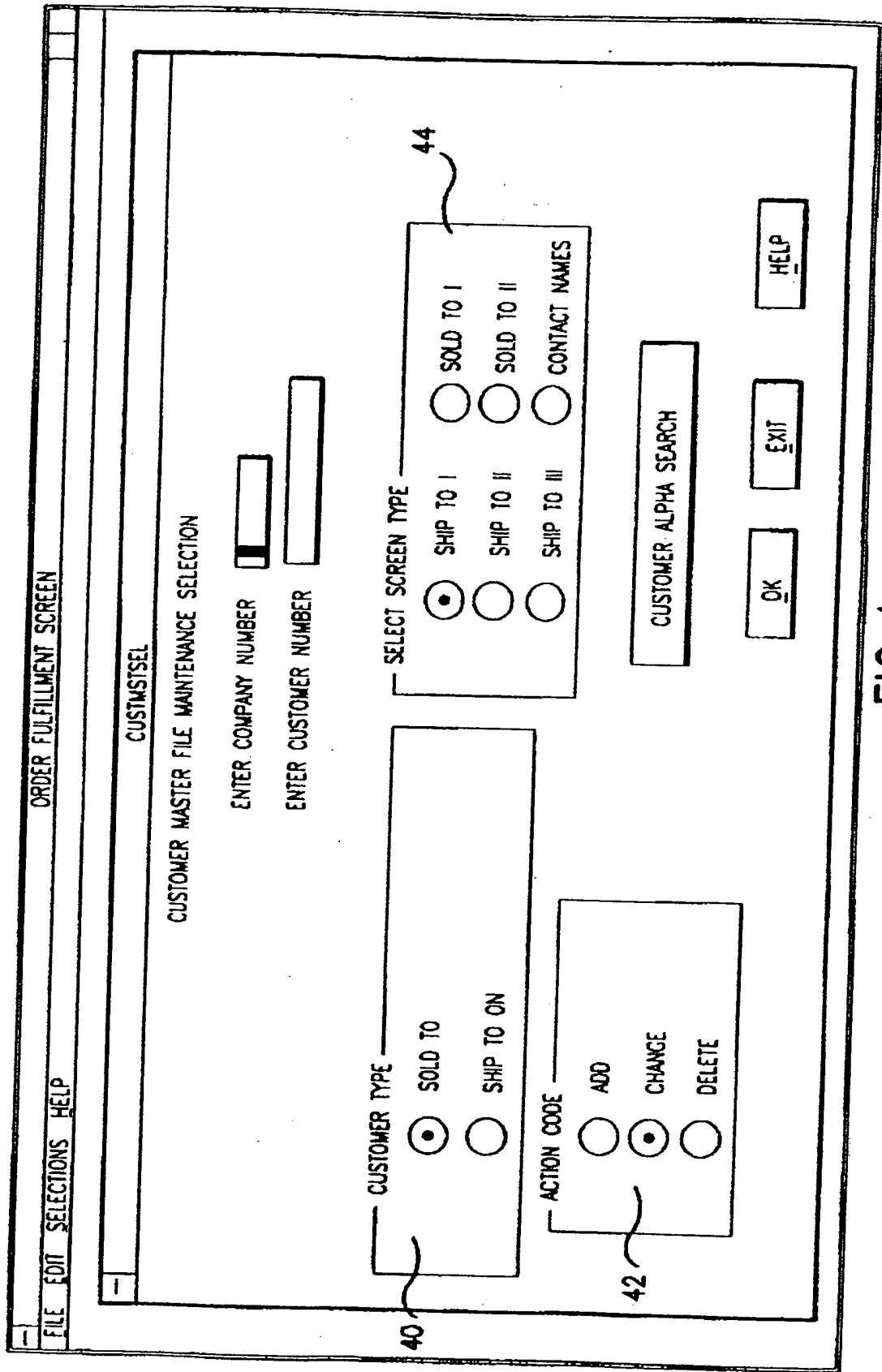

FIG.4



FILE EDIT SELECTIONS HELP ORDER FULFILLMENT SCREEN

ARDCUM1 PAGE

MAINTAIN CUSTOMER MASTER CONTROLS

999999  ACTIVE

USO

LYKES RECREATIONAL DATA CENTER

HIGHWAY 54 EAST

ZEPHYRILLS

22532

131348155

NATURAL ACCOUNT

PARENT (CO/CUSTOMER)

TAX ID

SALES LEVEL ID

SALESPERSON CODE

LOCKBOX NUMBER

STATEMENT DESTINATION

STATE  FL COUNTY

FAX 1321326541

STATEMENT ORDER

BILL TO  46

SHIP TO  48

OK CANCEL EXIT

FIG.5



ORDER ENTRY

ORDER ENTRY    AVAILABILITY    CUST SEARCH    RES SEARCH    OVERRIDE

ORDER ENTRY

ORDER FORM

ORDER /

SALES RESUME	RESOURCE DESCRIPTION	ORDER	DISCOUNT	DISCOUNT	DISCOUNT	DISCOUNT
<input type="checkbox"/>		.000000	<input type="checkbox"/>	<input type="checkbox"/>	<input type="checkbox"/>	<input type="checkbox"/>
<input type="checkbox"/>		TOTAL AMOUNT	SM/	SM/	SM/	SM/
<input type="checkbox"/>		.000000	<input type="checkbox"/>	<input type="checkbox"/>	<input type="checkbox"/>	<input type="checkbox"/>
<input type="checkbox"/>		TOTAL AMOUNT	SM/	SM/	SM/	SM/
<input type="checkbox"/>		.000000	<input type="checkbox"/>	<input type="checkbox"/>	<input type="checkbox"/>	<input type="checkbox"/>
<input type="checkbox"/>		TOTAL AMOUNT	SM/	SM/	SM/	SM/
<input type="checkbox"/>		.000000	<input type="checkbox"/>	<input type="checkbox"/>	<input type="checkbox"/>	<input type="checkbox"/>
<input type="checkbox"/>		TOTAL AMOUNT	SM/	SM/	SM/	SM/

OPTIONS     REPRICE     REDISPLAY  
 SWITCH     RETURN     OK  
 PREVIOUS     TOTAL     CANCEL     MORE     REFRESH     HELP  
 OVERIDE LIST

FIG.6



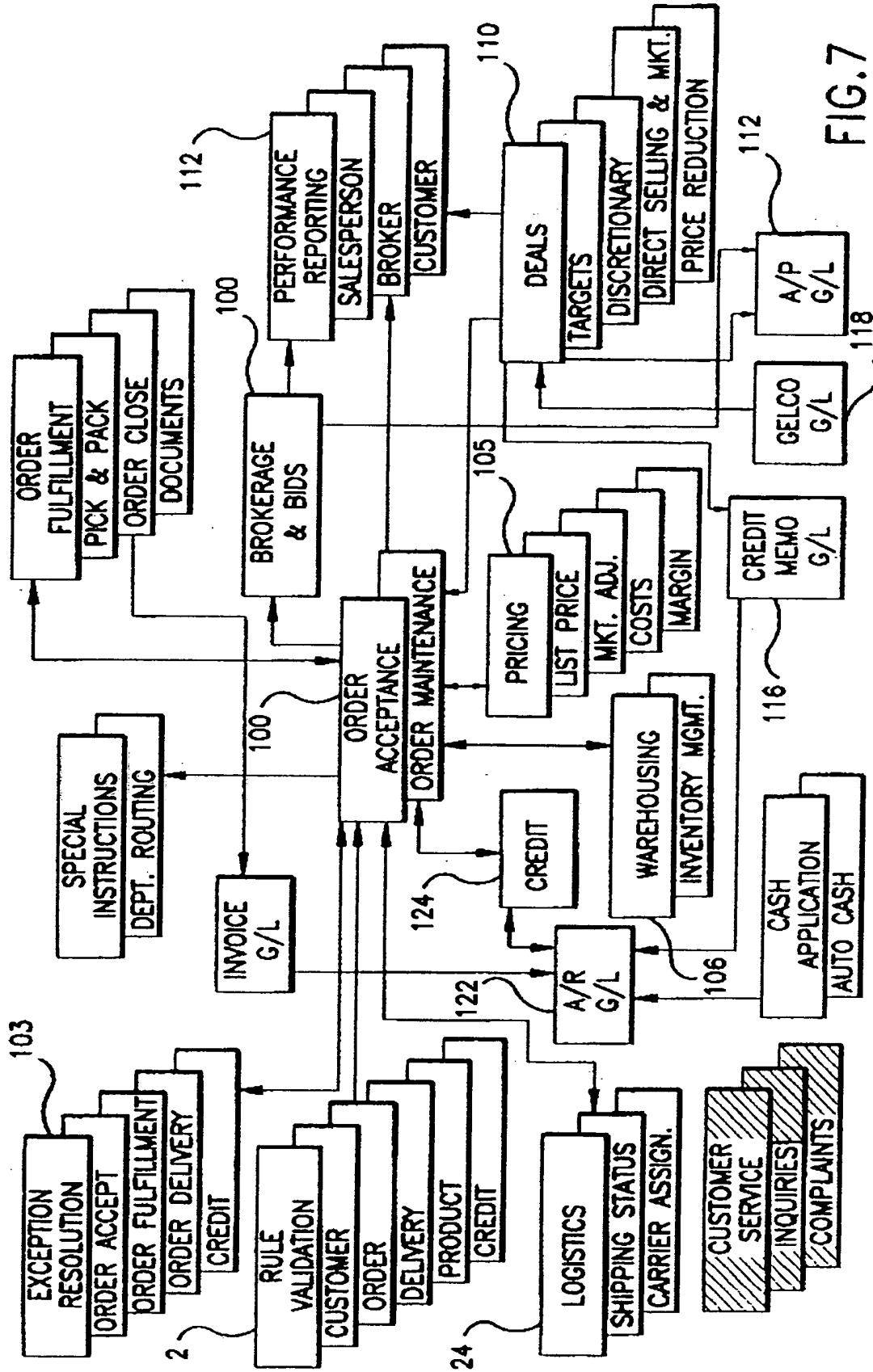

FIG. 7

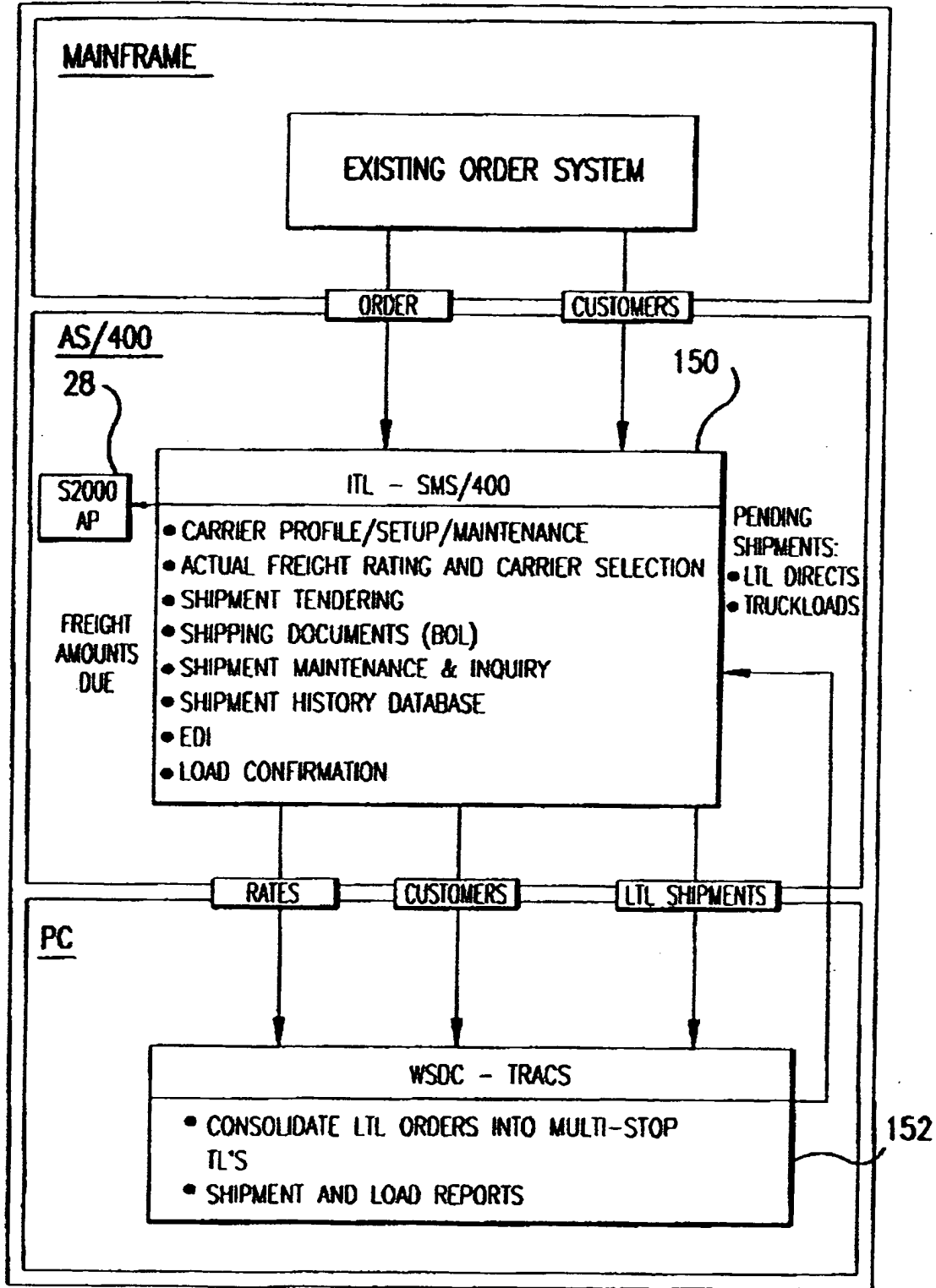

FIG.8

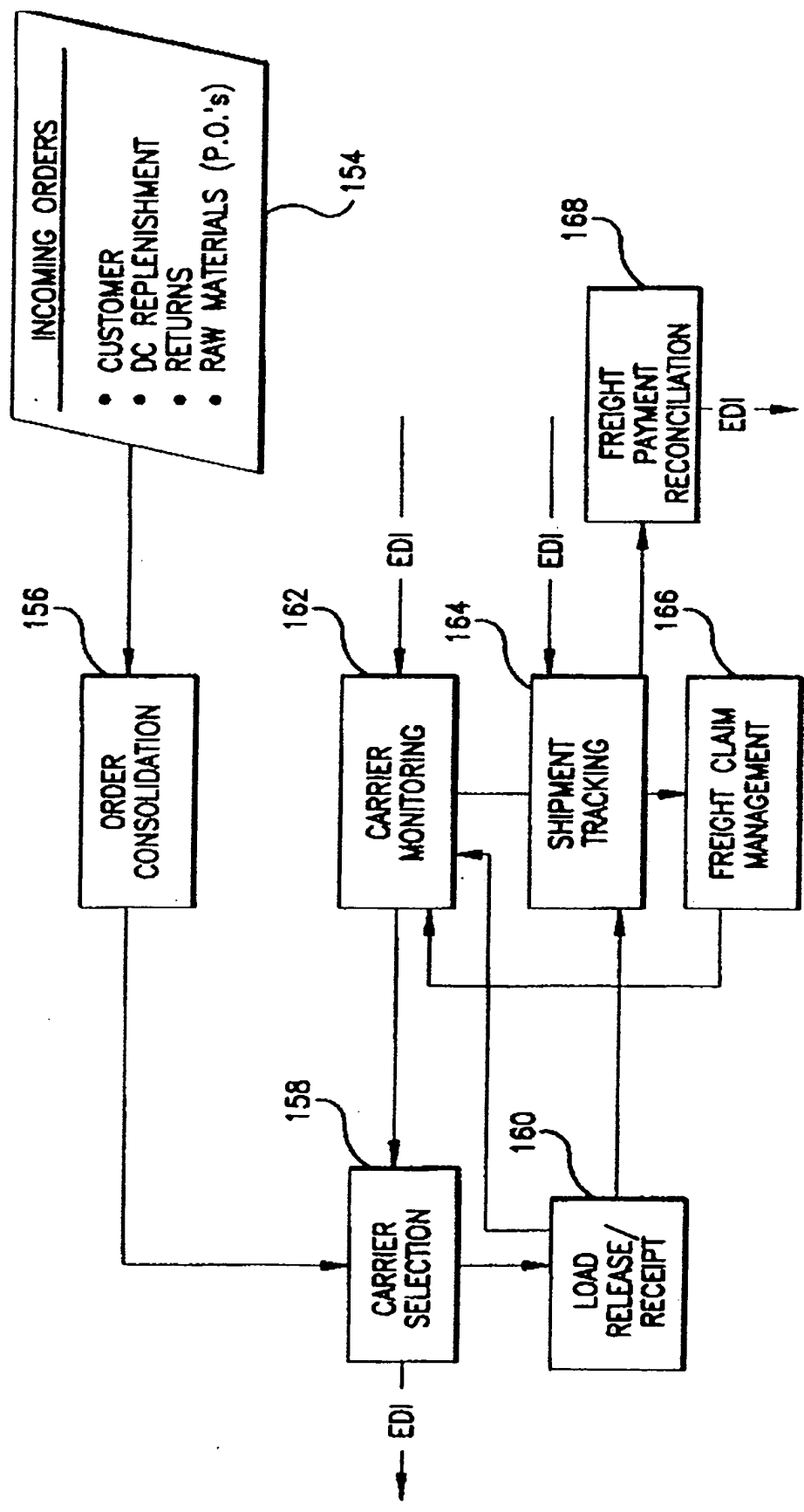

FIG. 9

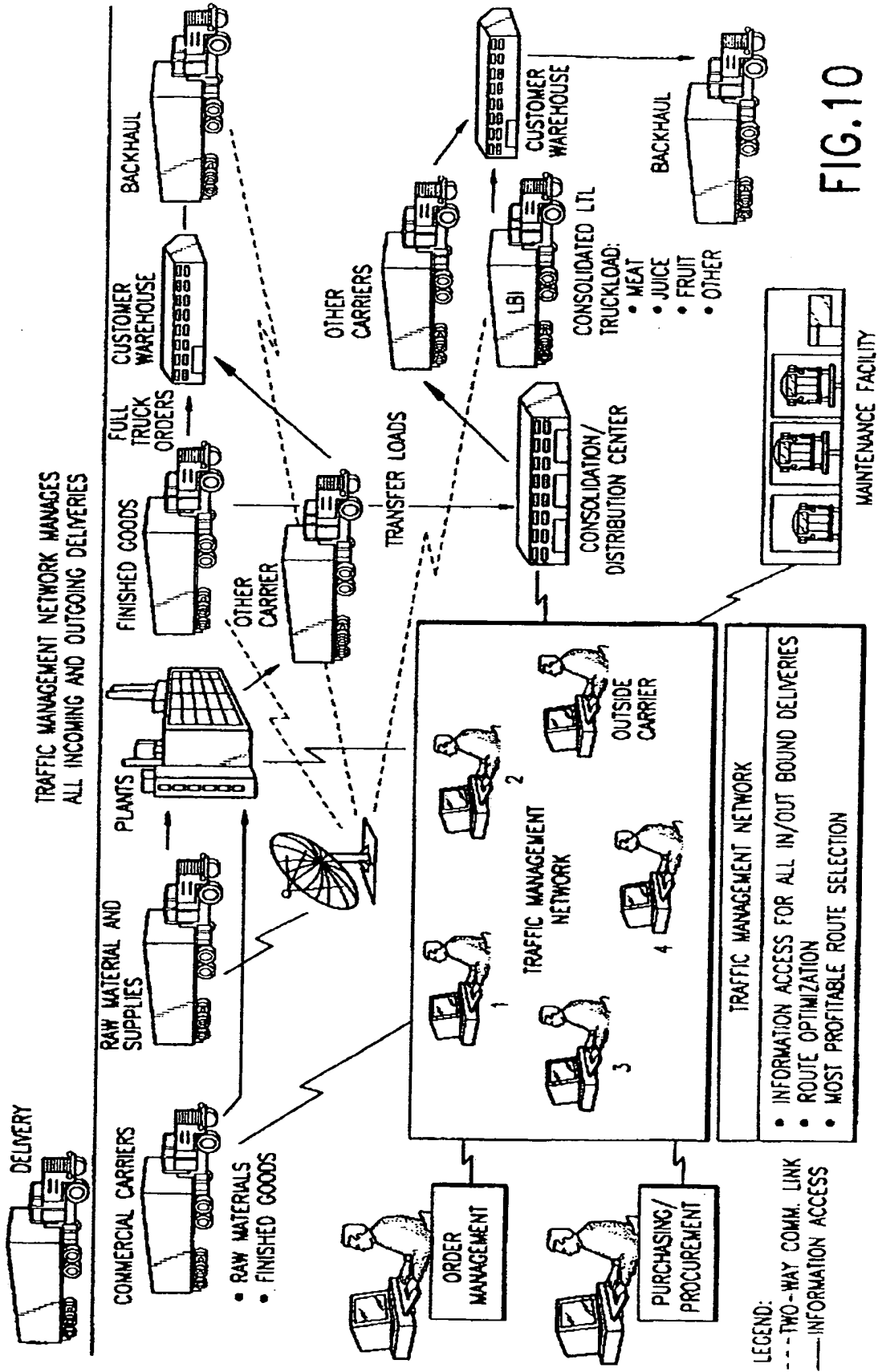

FIG.10

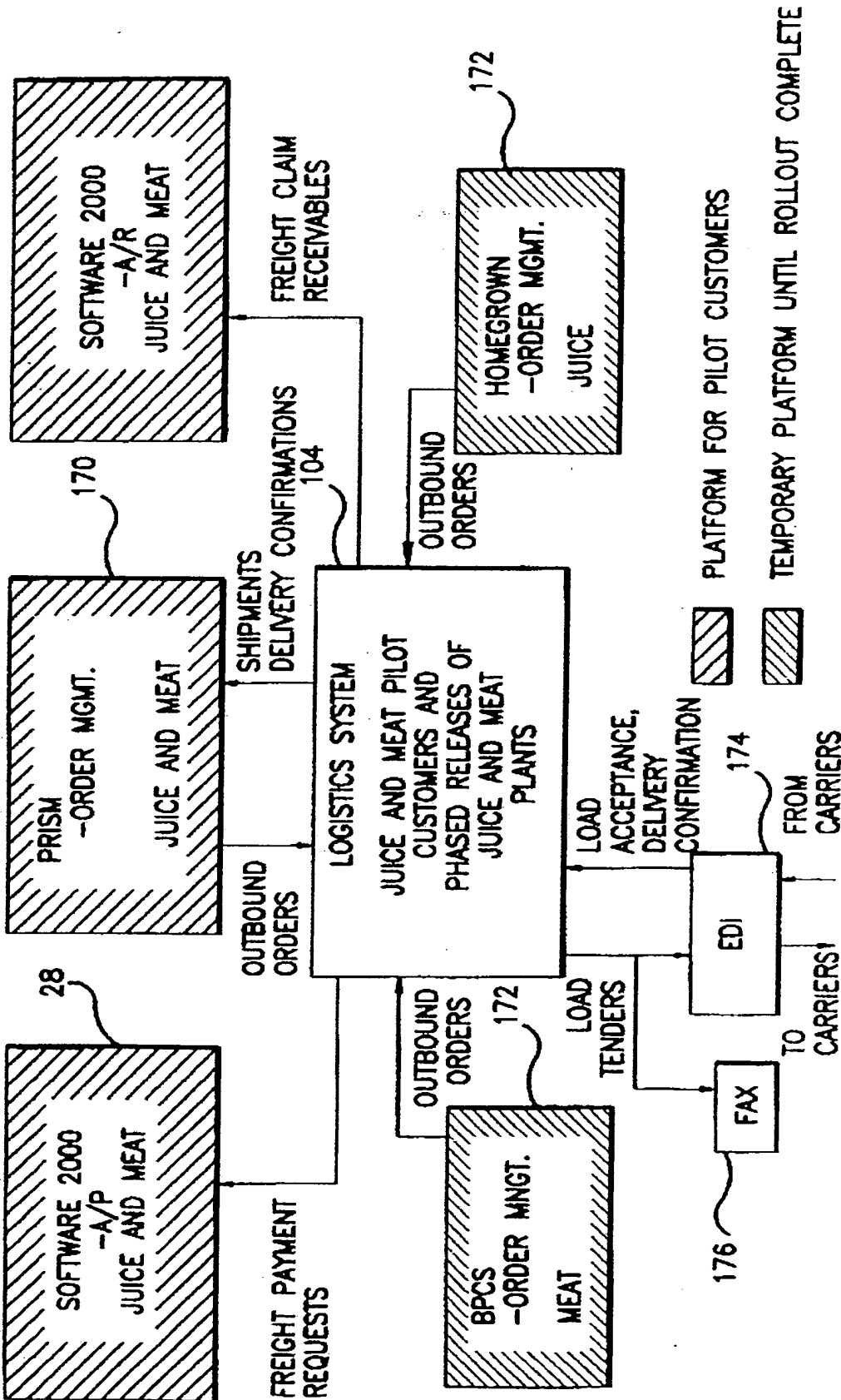

FIG.11

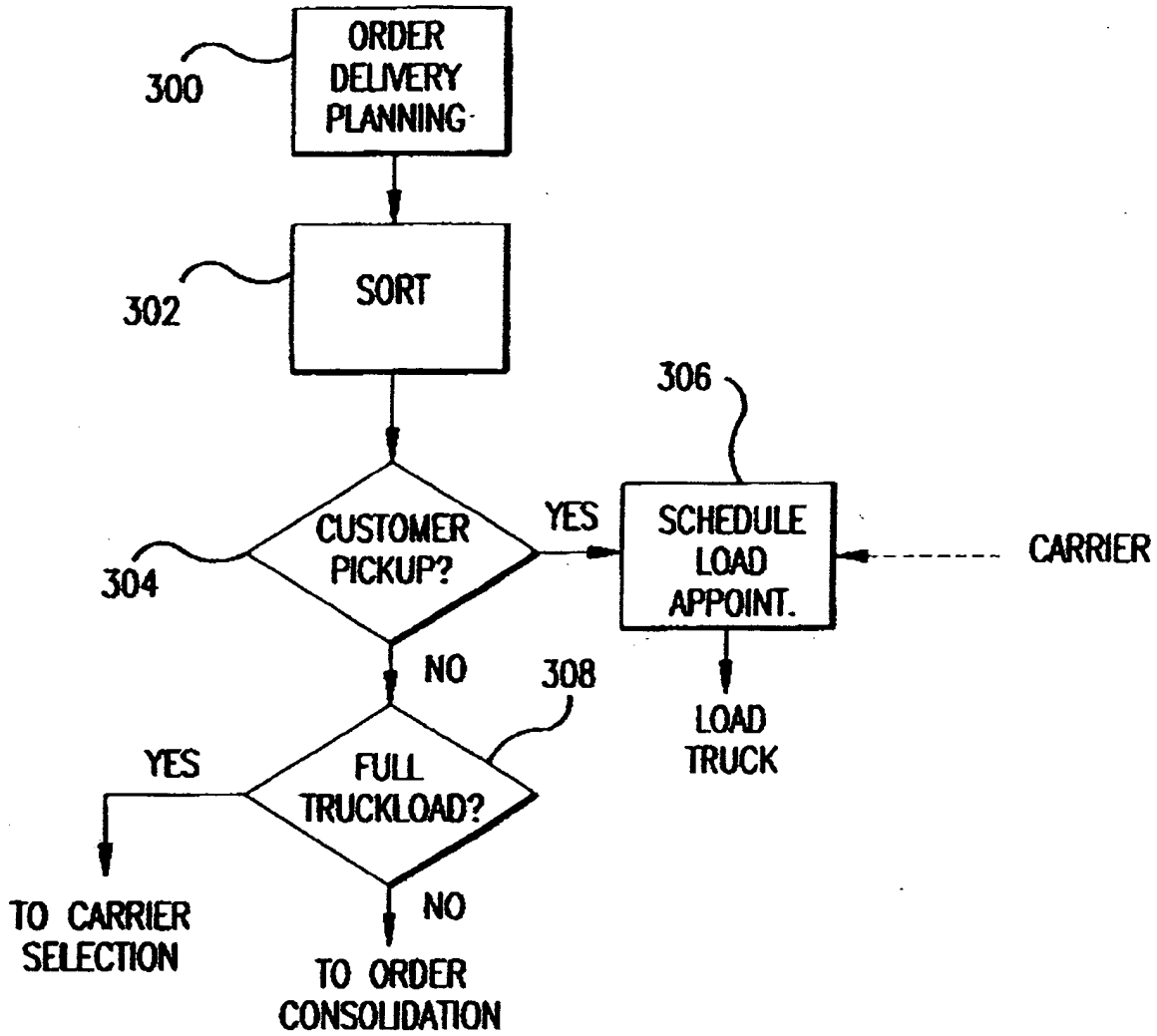

FIG.12

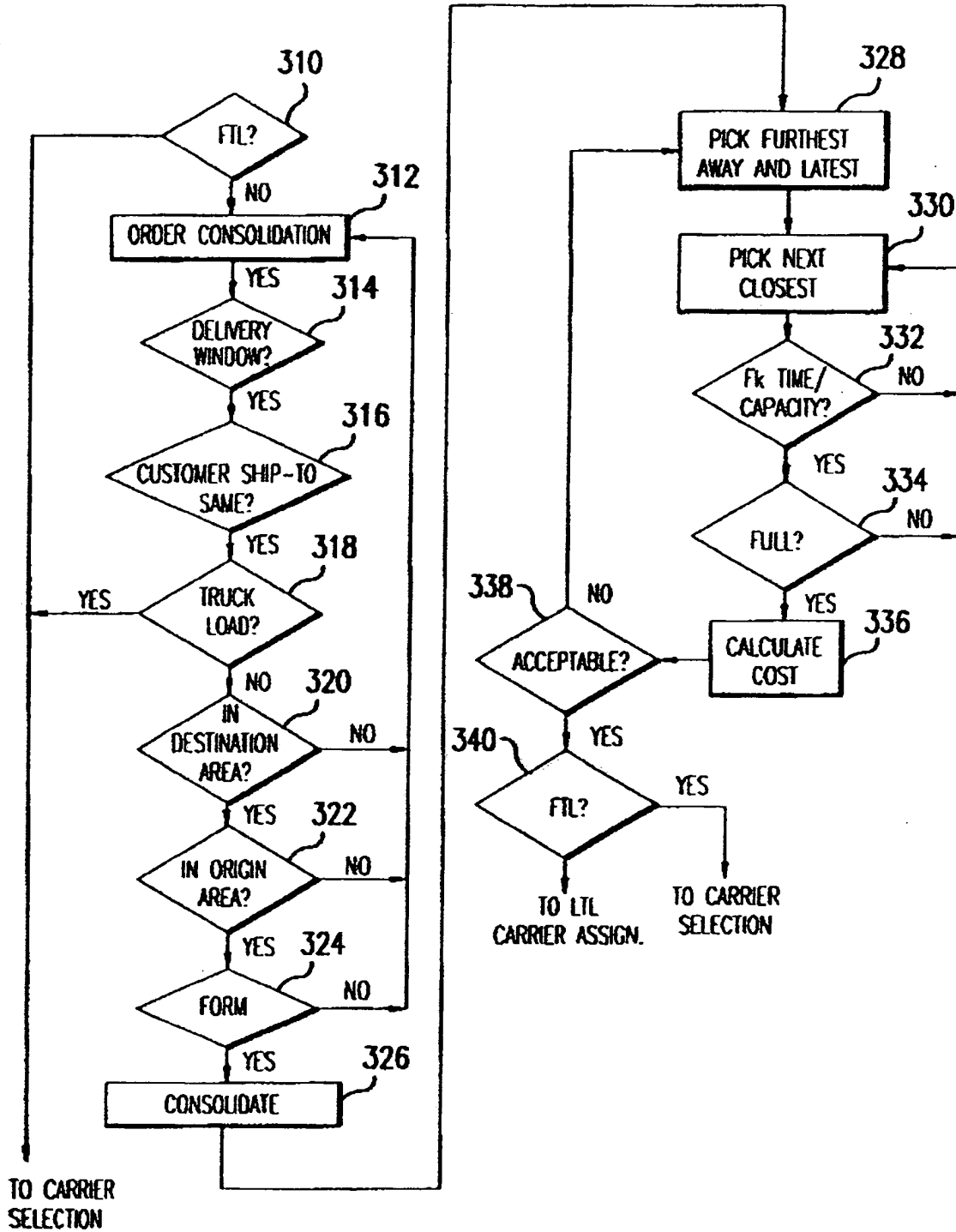

FIG.13

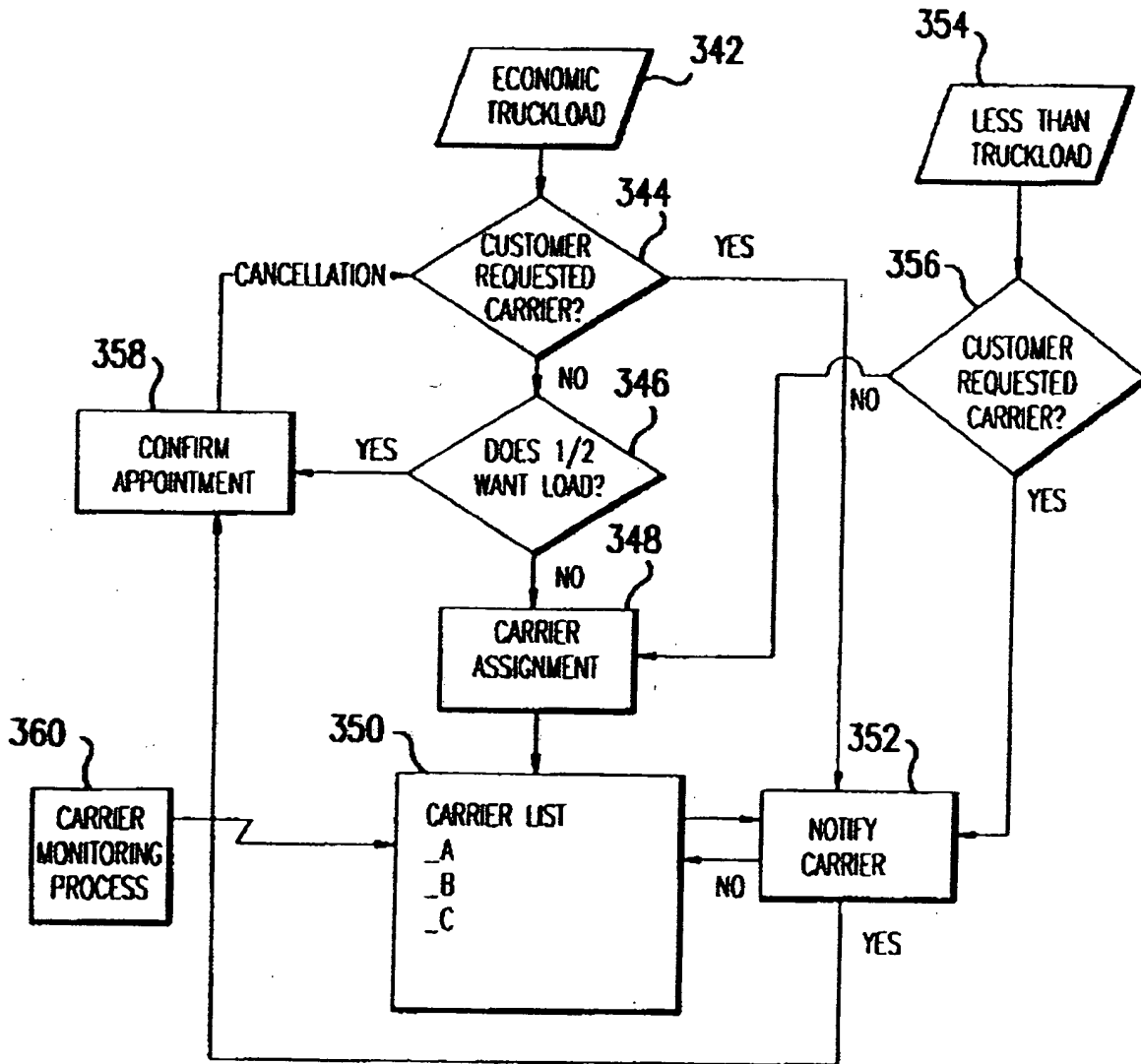

FIG. 14



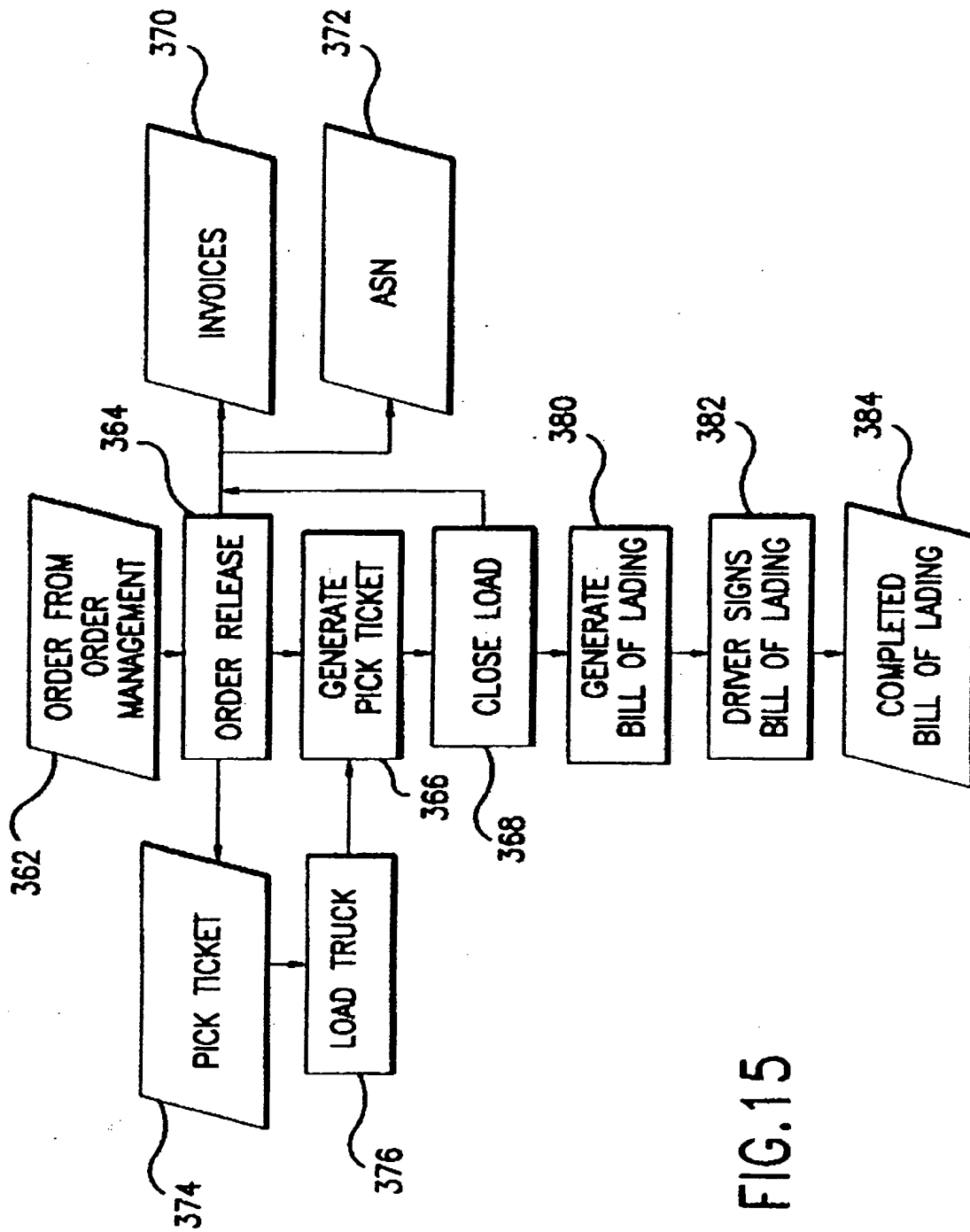

FIG.15

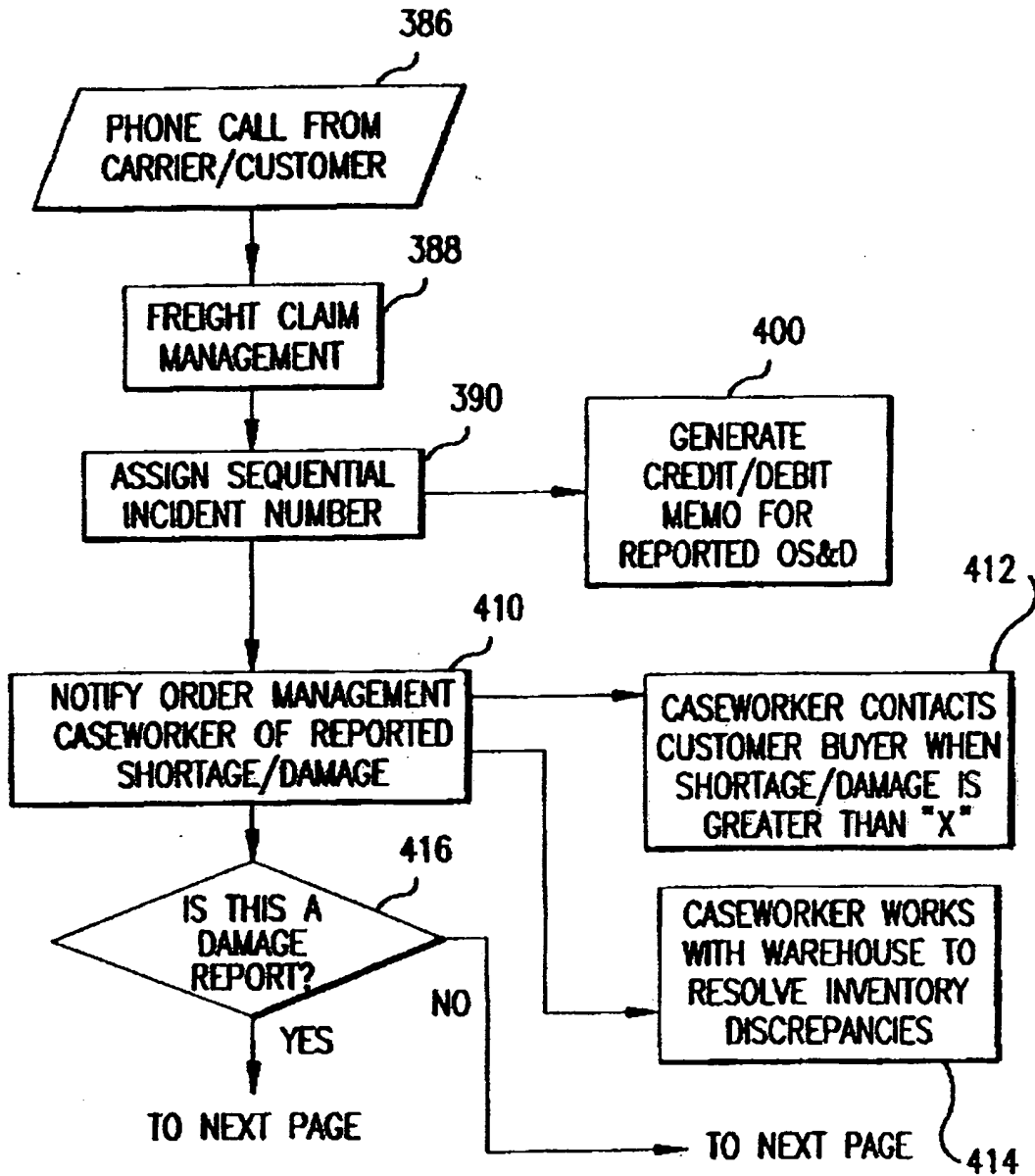

FIG.16

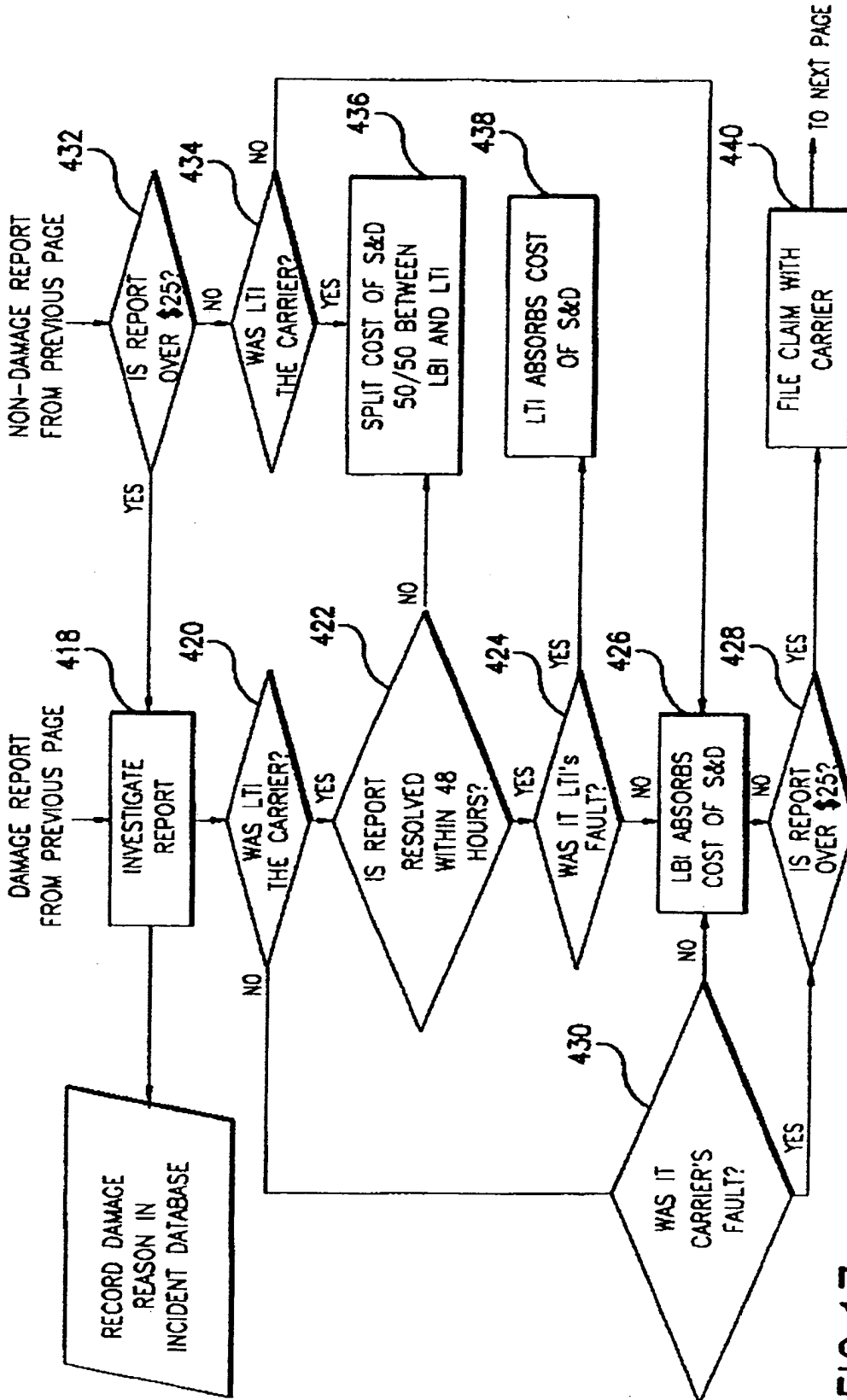

FIG.17

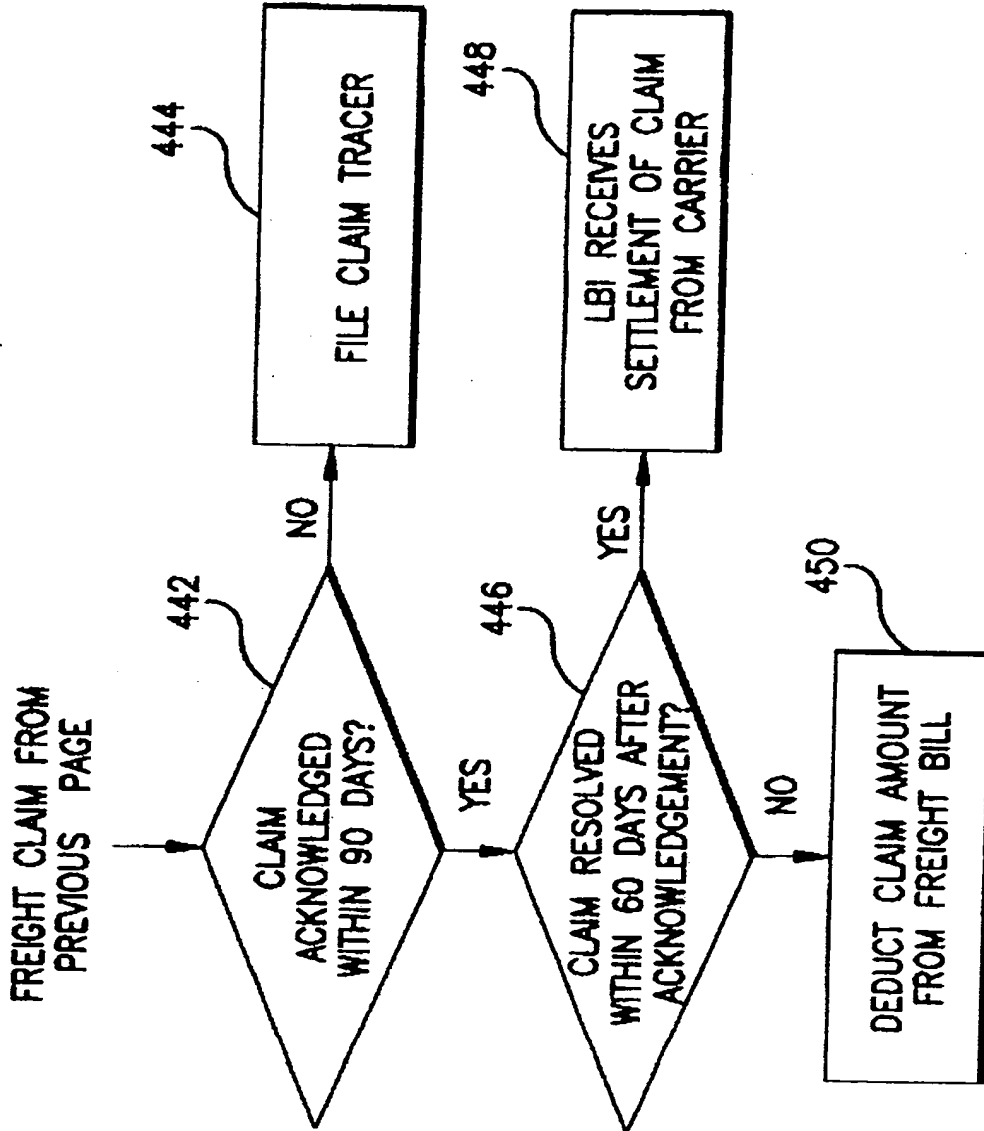

FIG.18

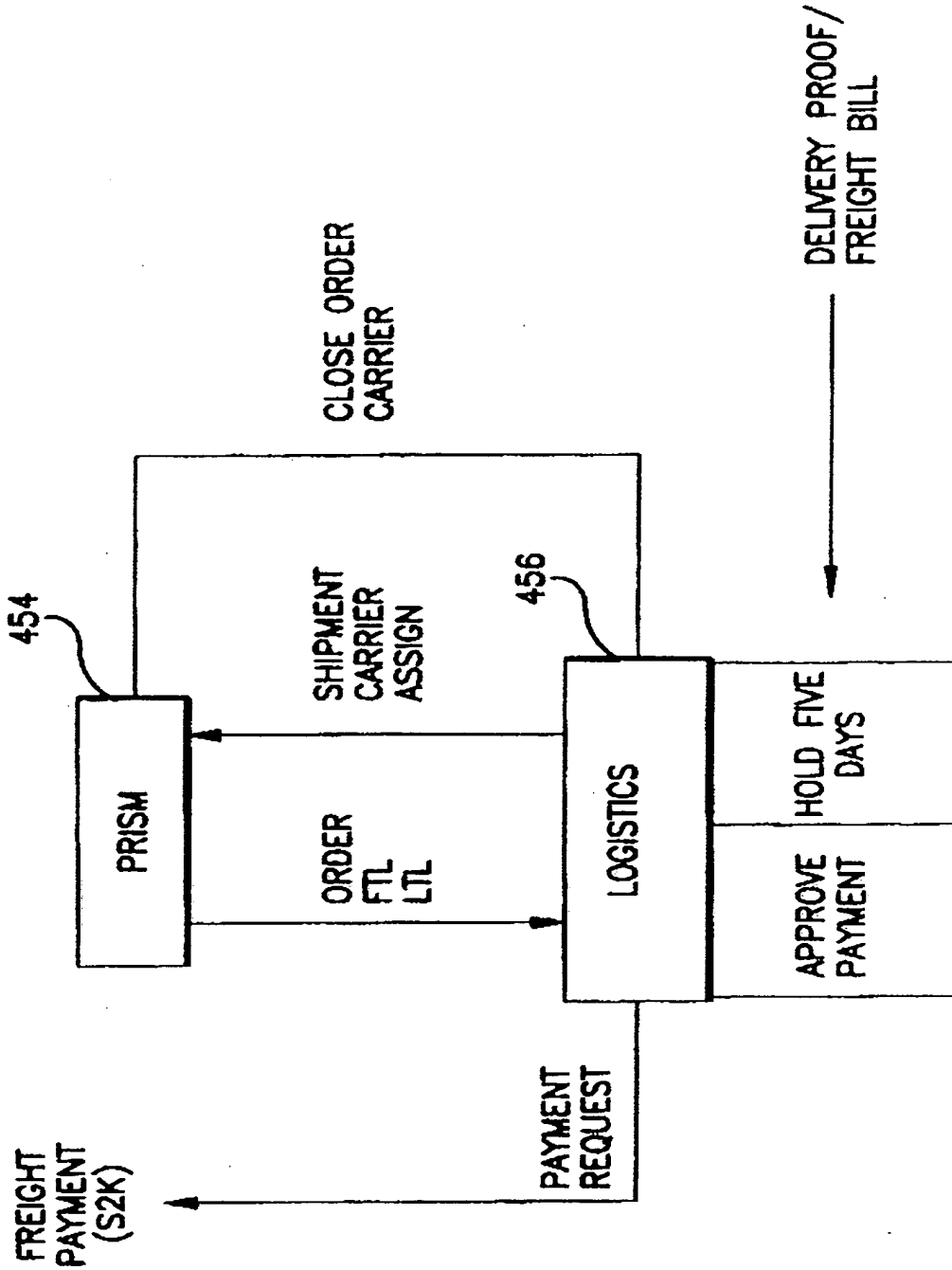

FIG.19

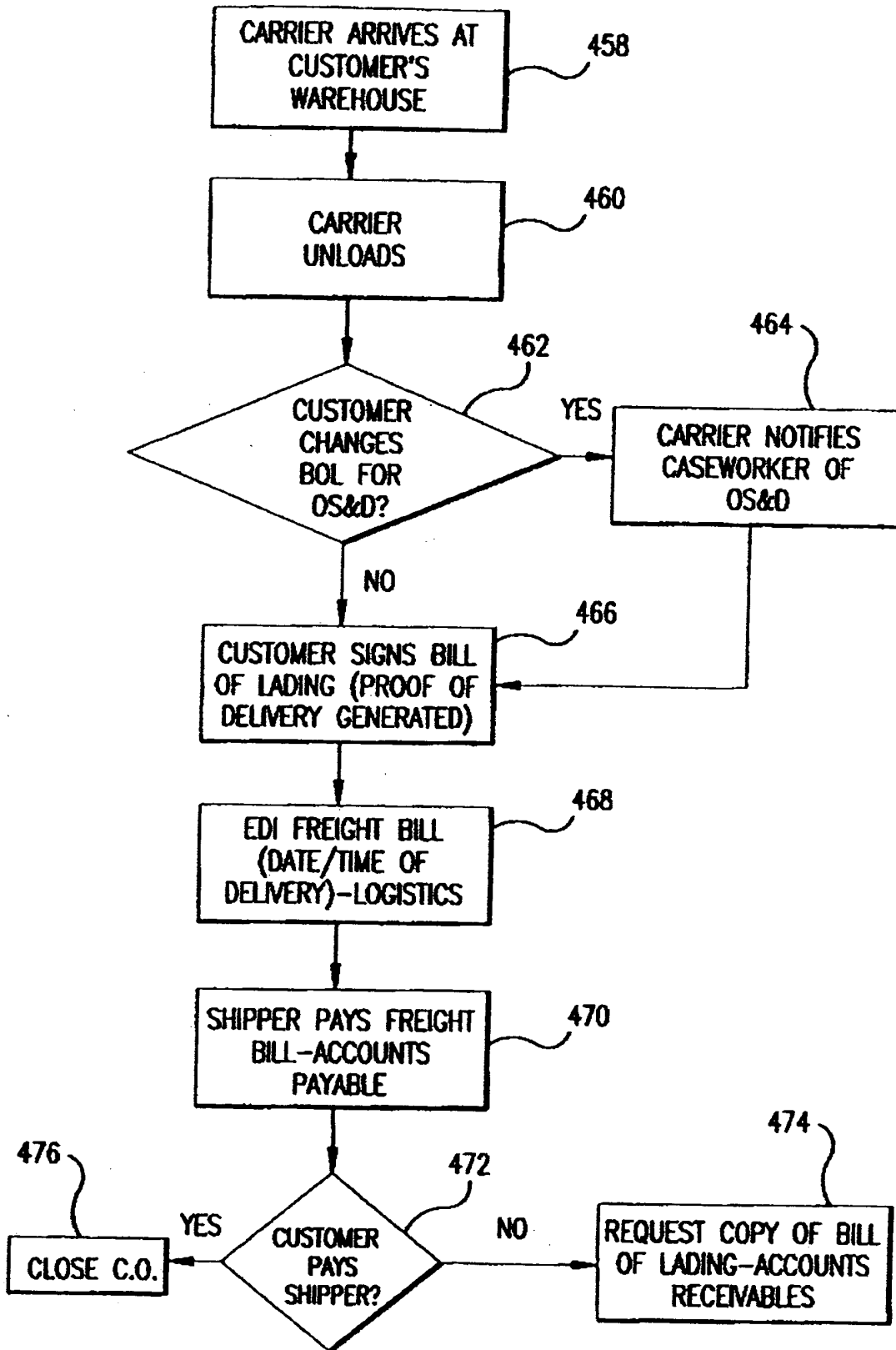

FIG. 20

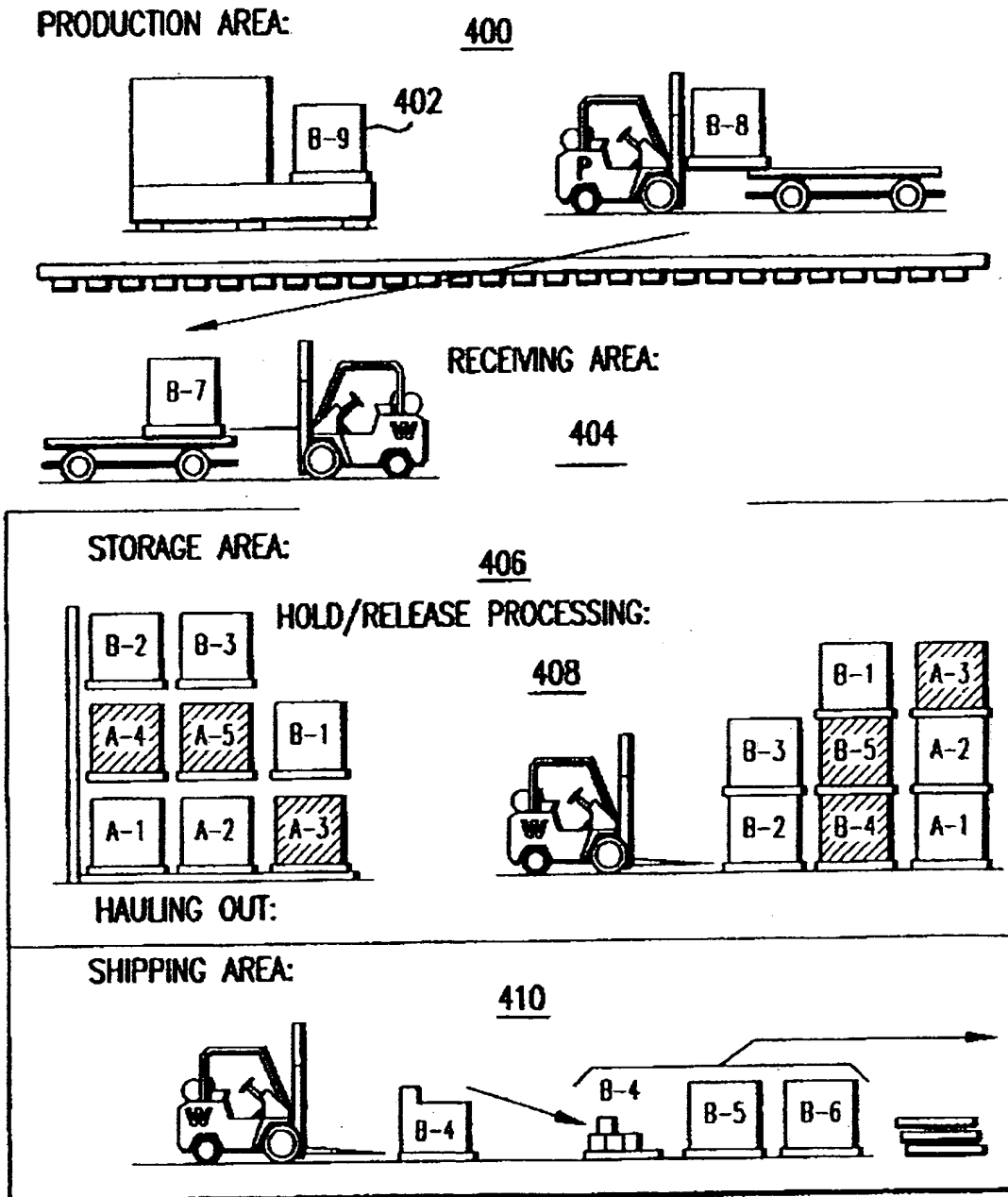

FIG.21

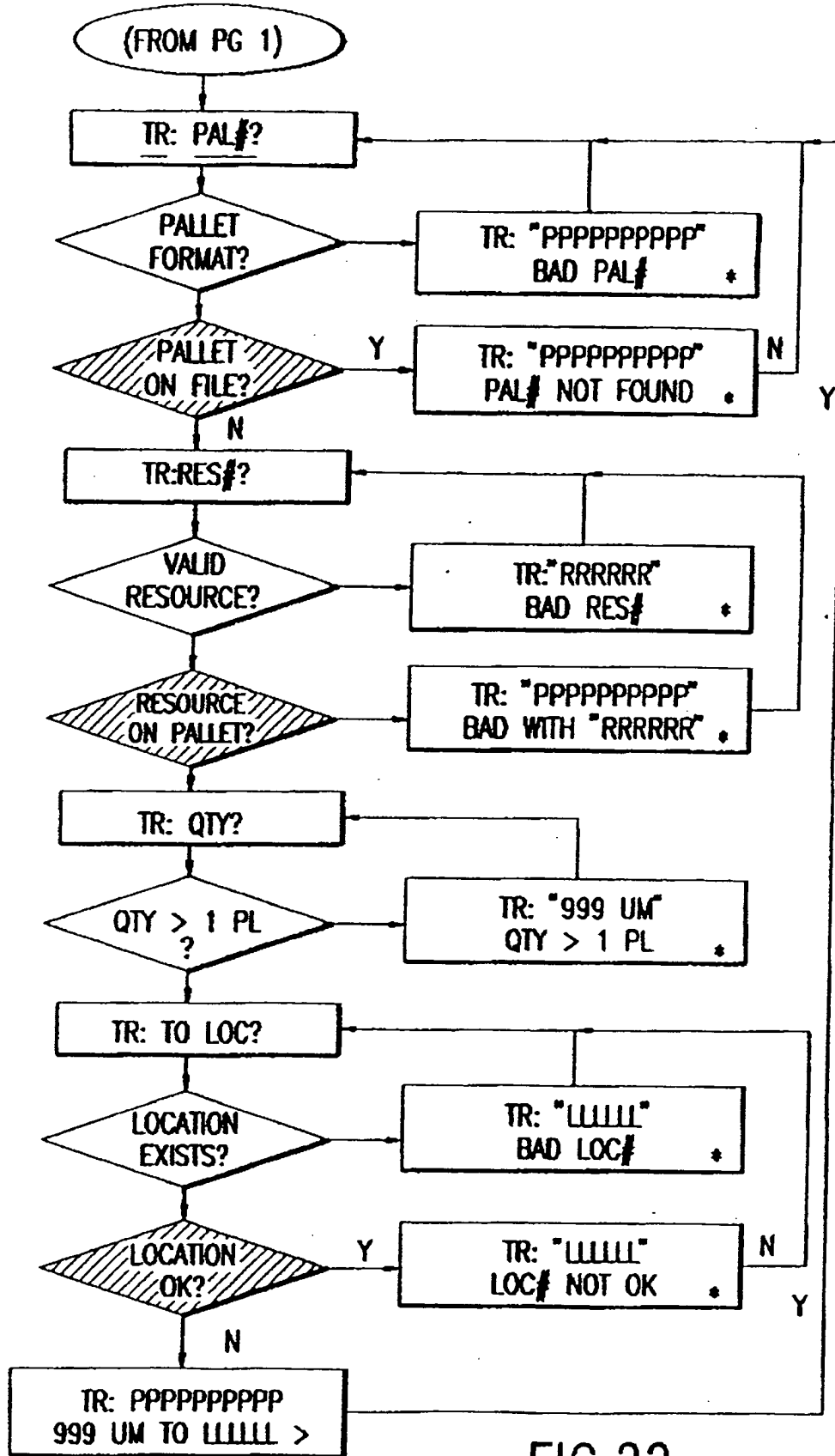
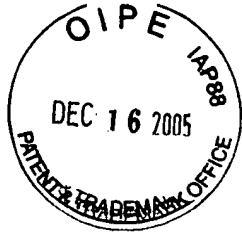

FIG.22



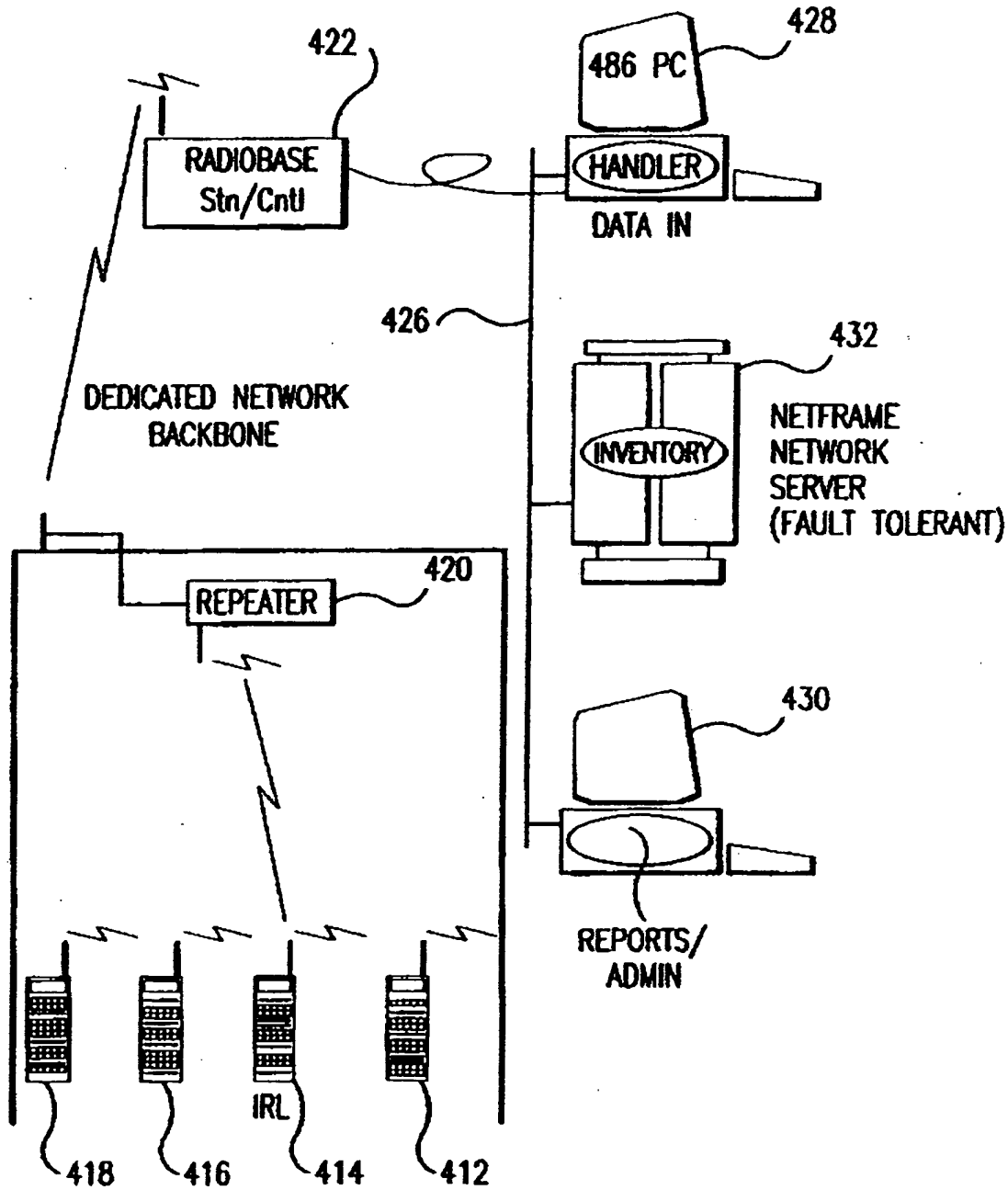

FIG.23

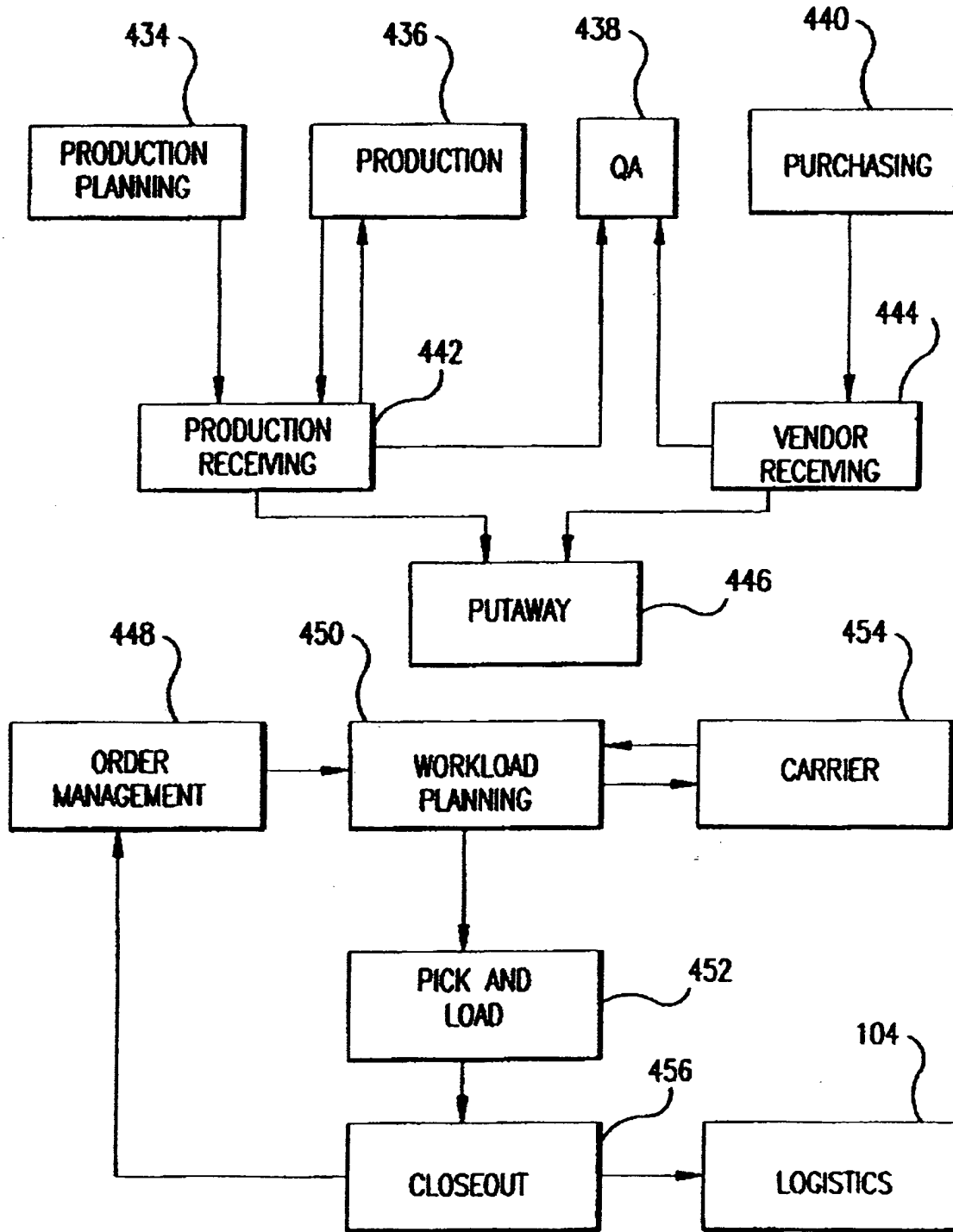

FIG. 24

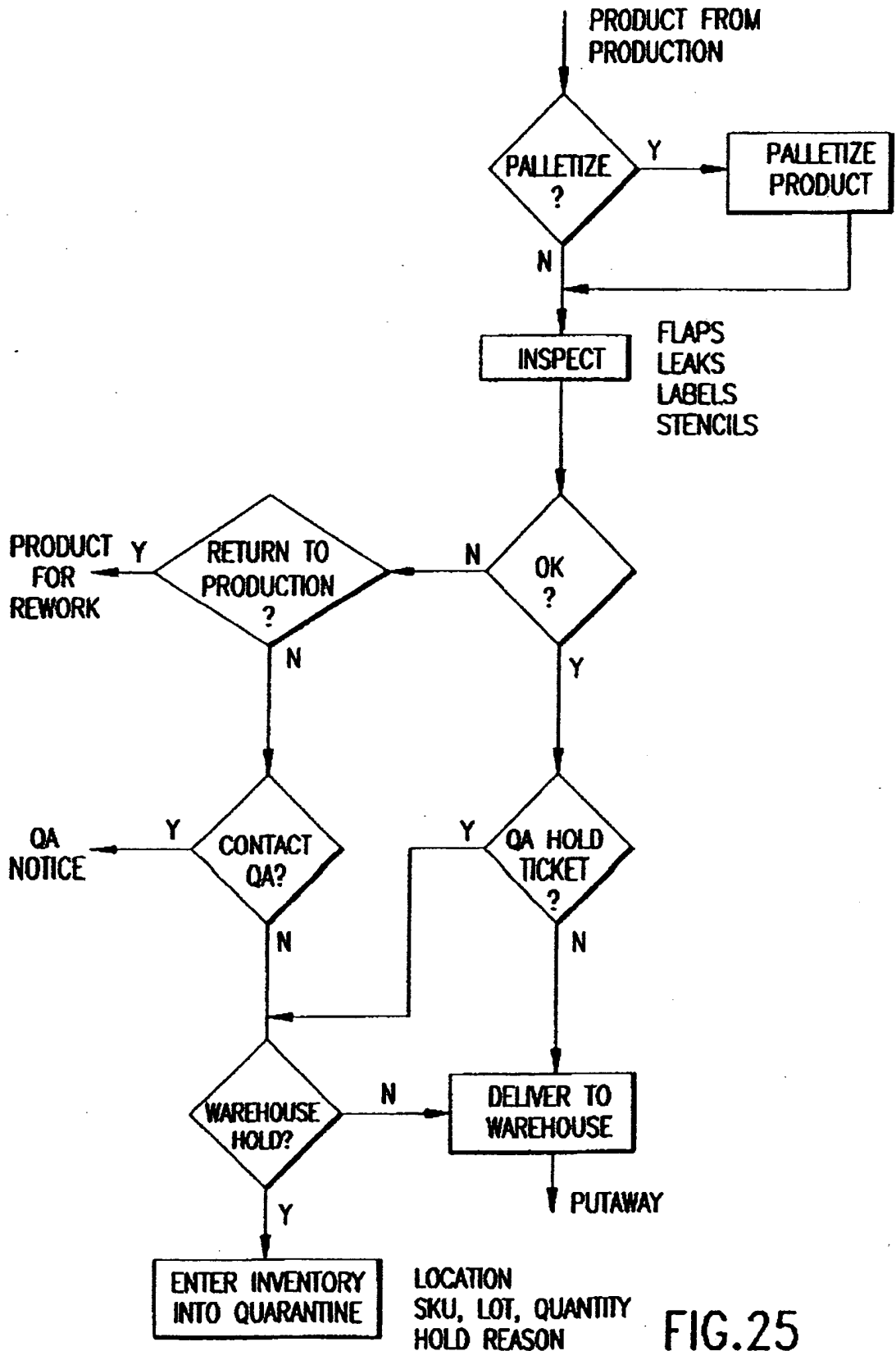

FIG.25

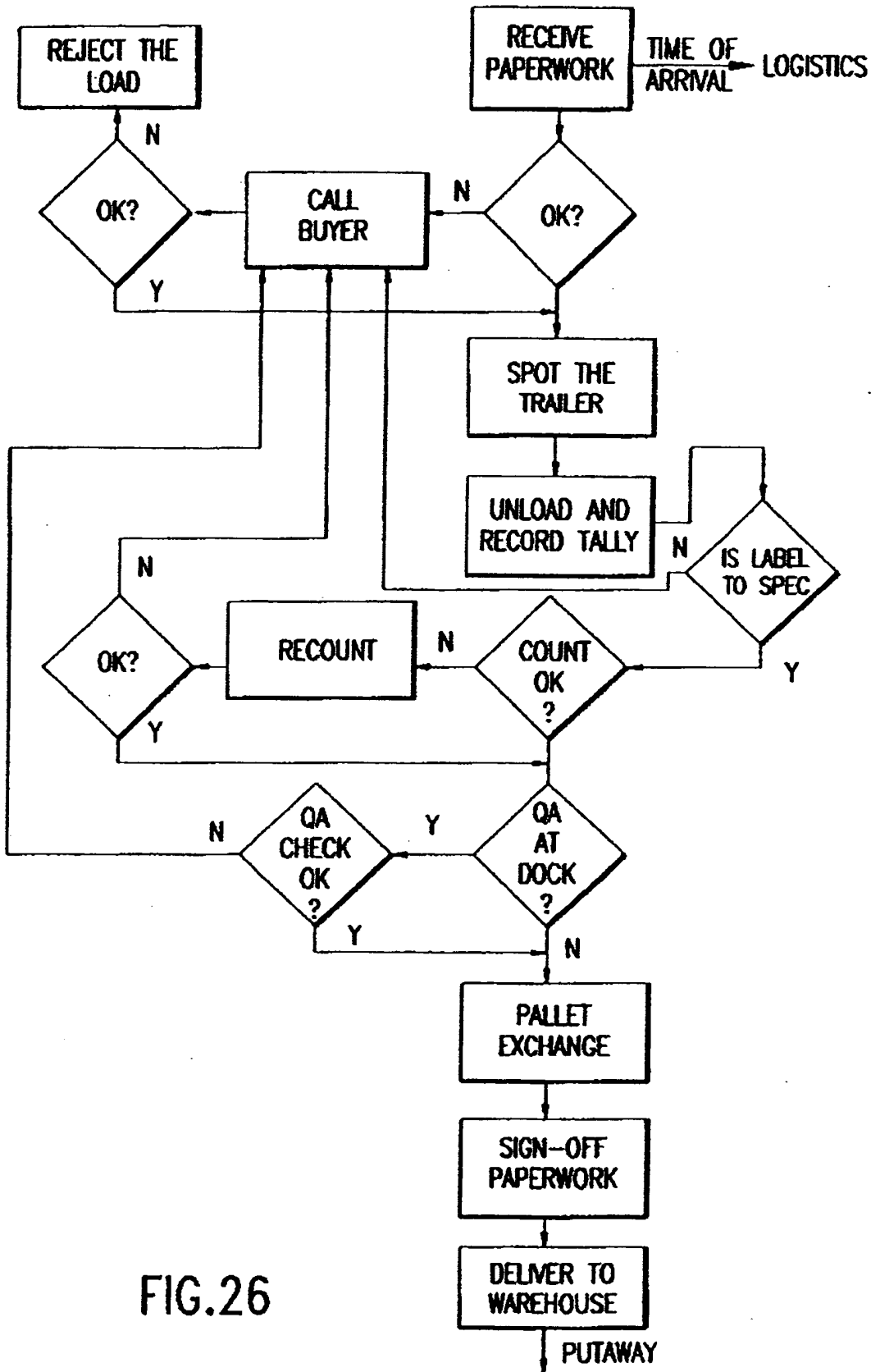

FIG.26

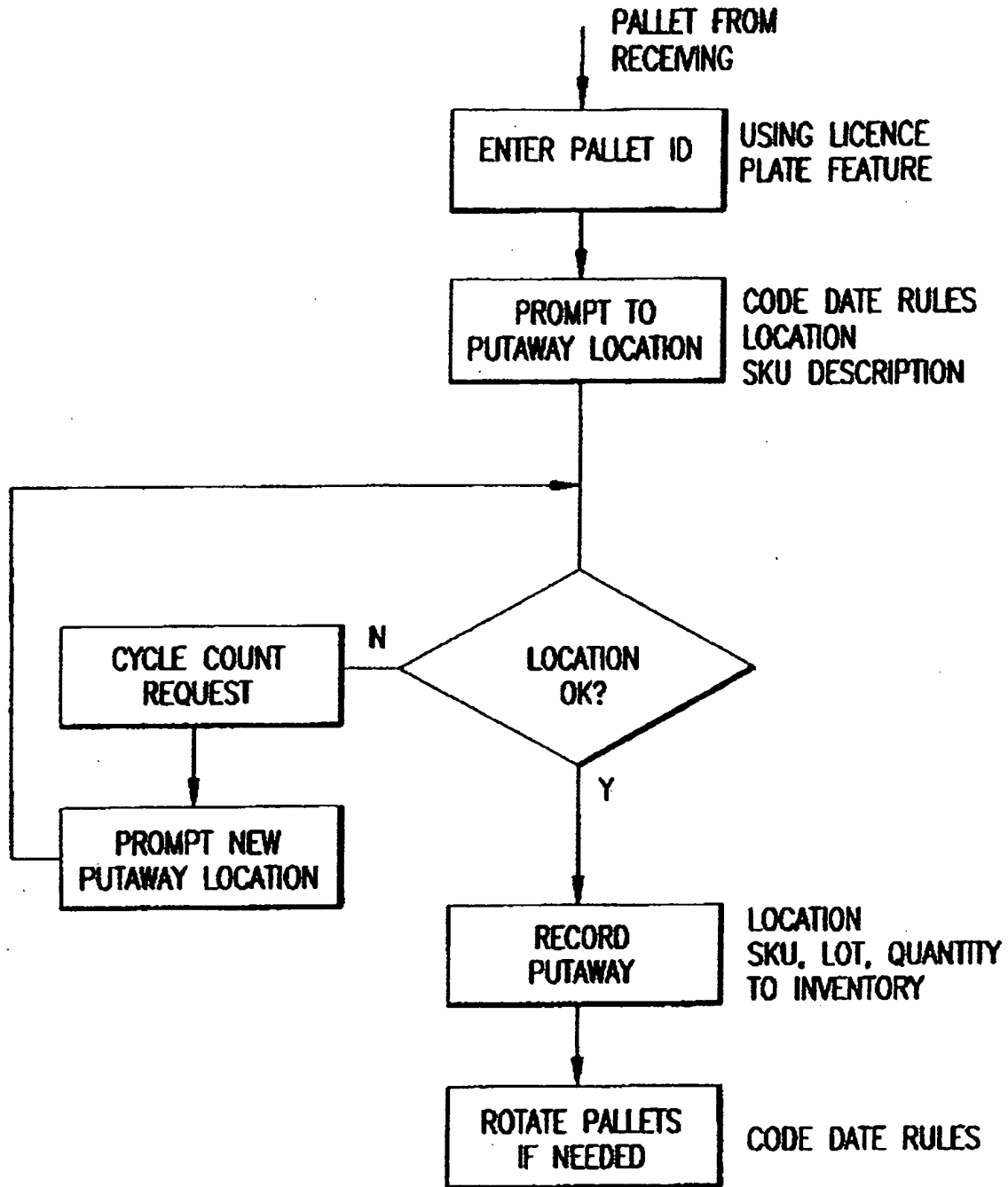

FIG.27



### WORKLOAD PLANNING

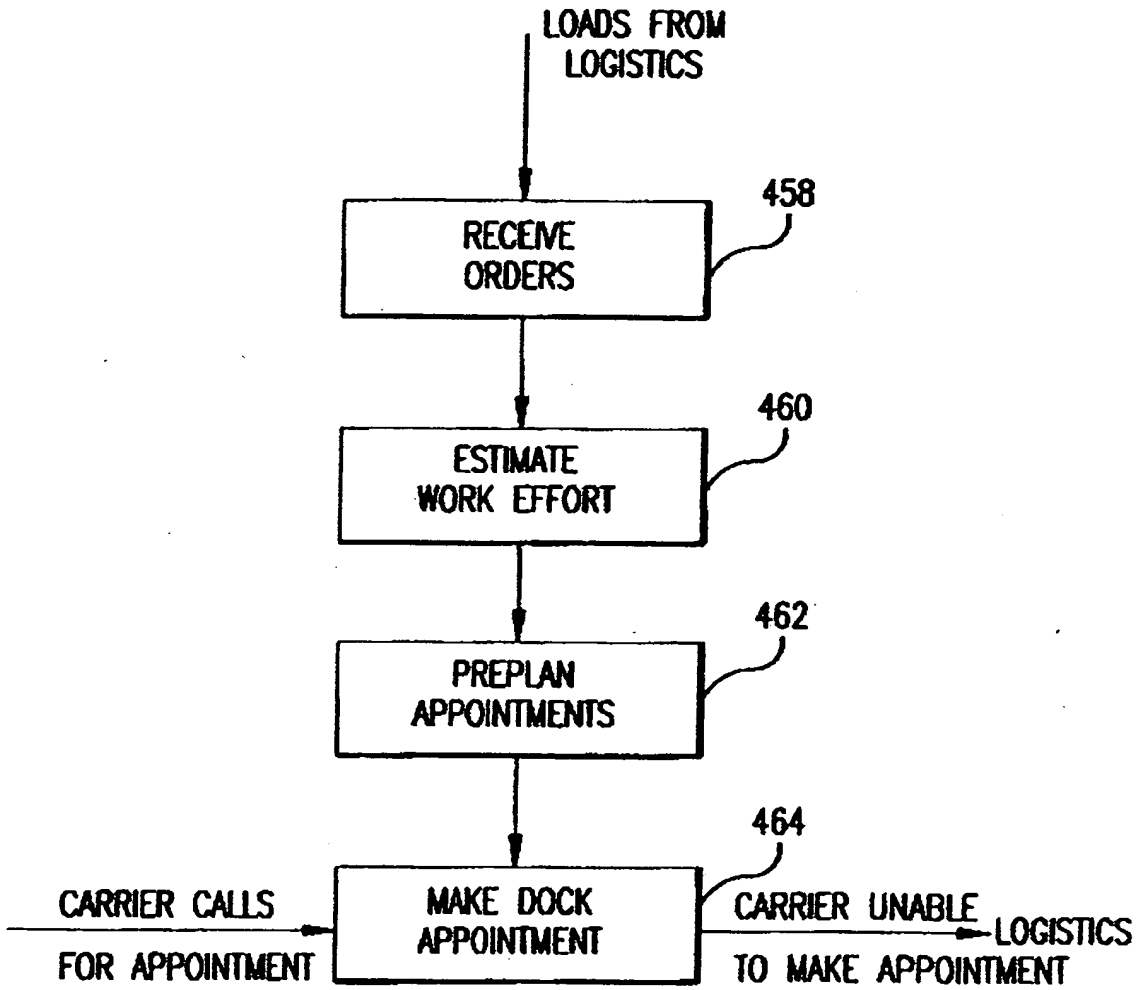

FIG.28



### ORDER PICK

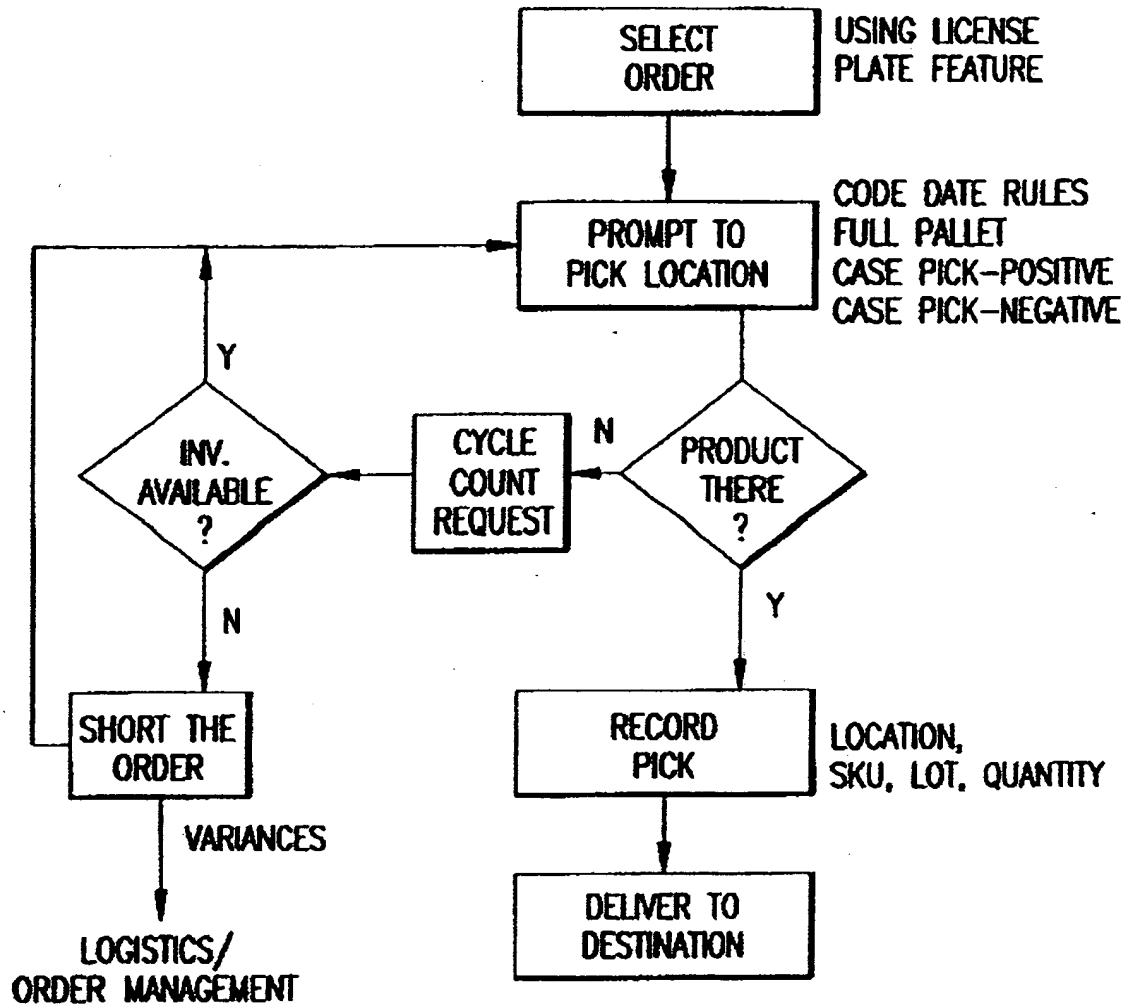

FIG.29



### BATCH PICK

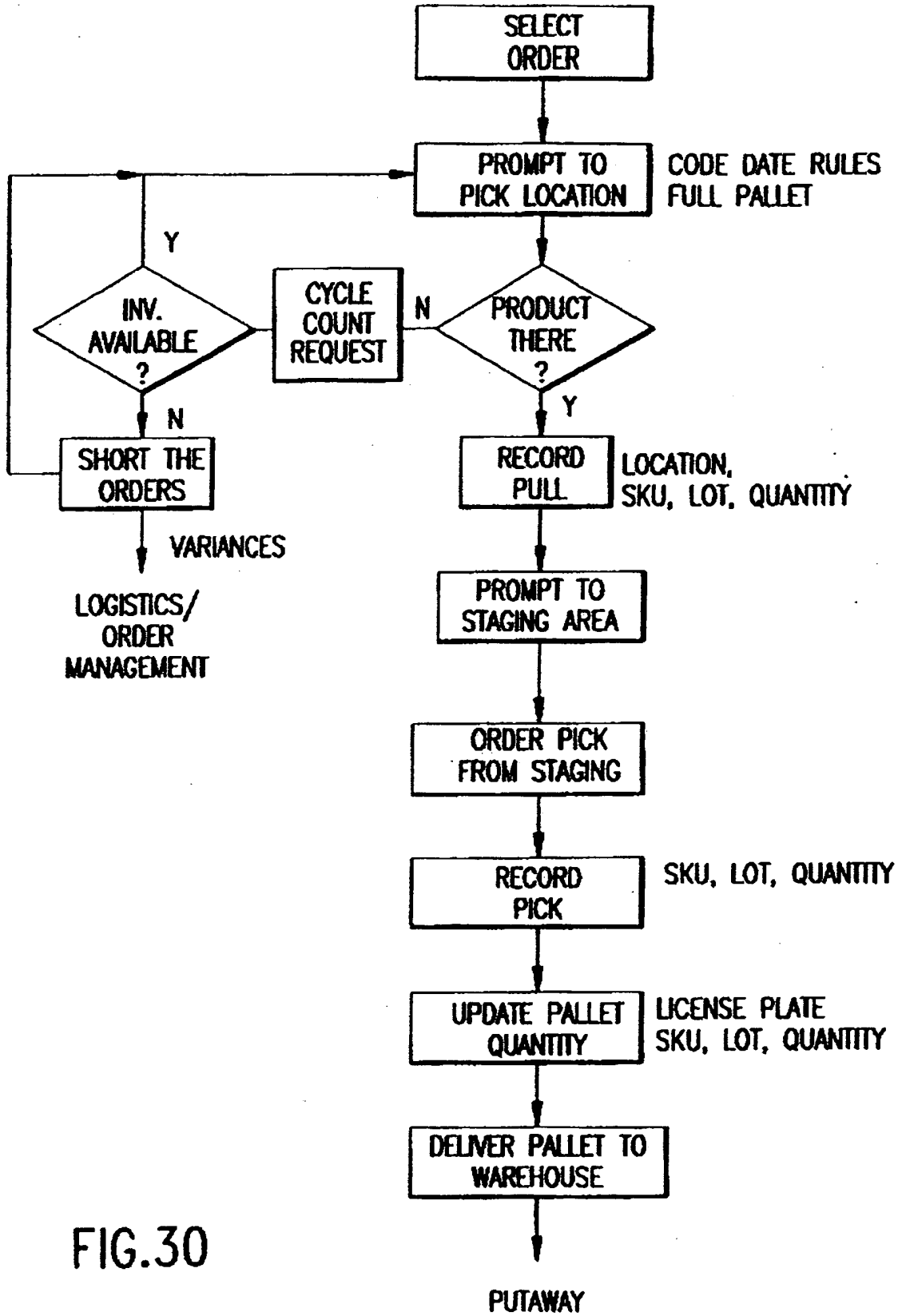

FIG.30





### ORDER LOAD AND CLOSEOUT

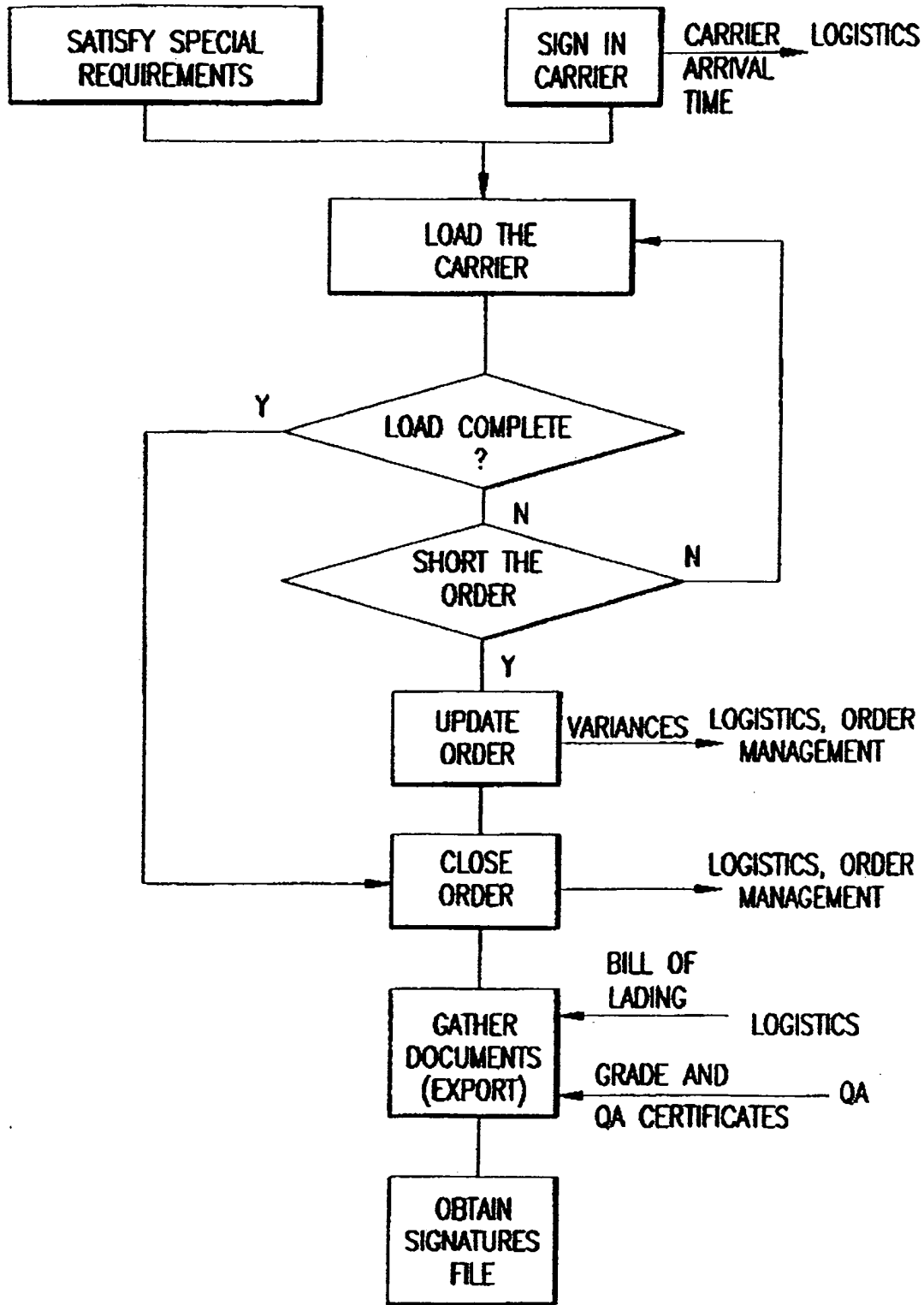

FIG.31

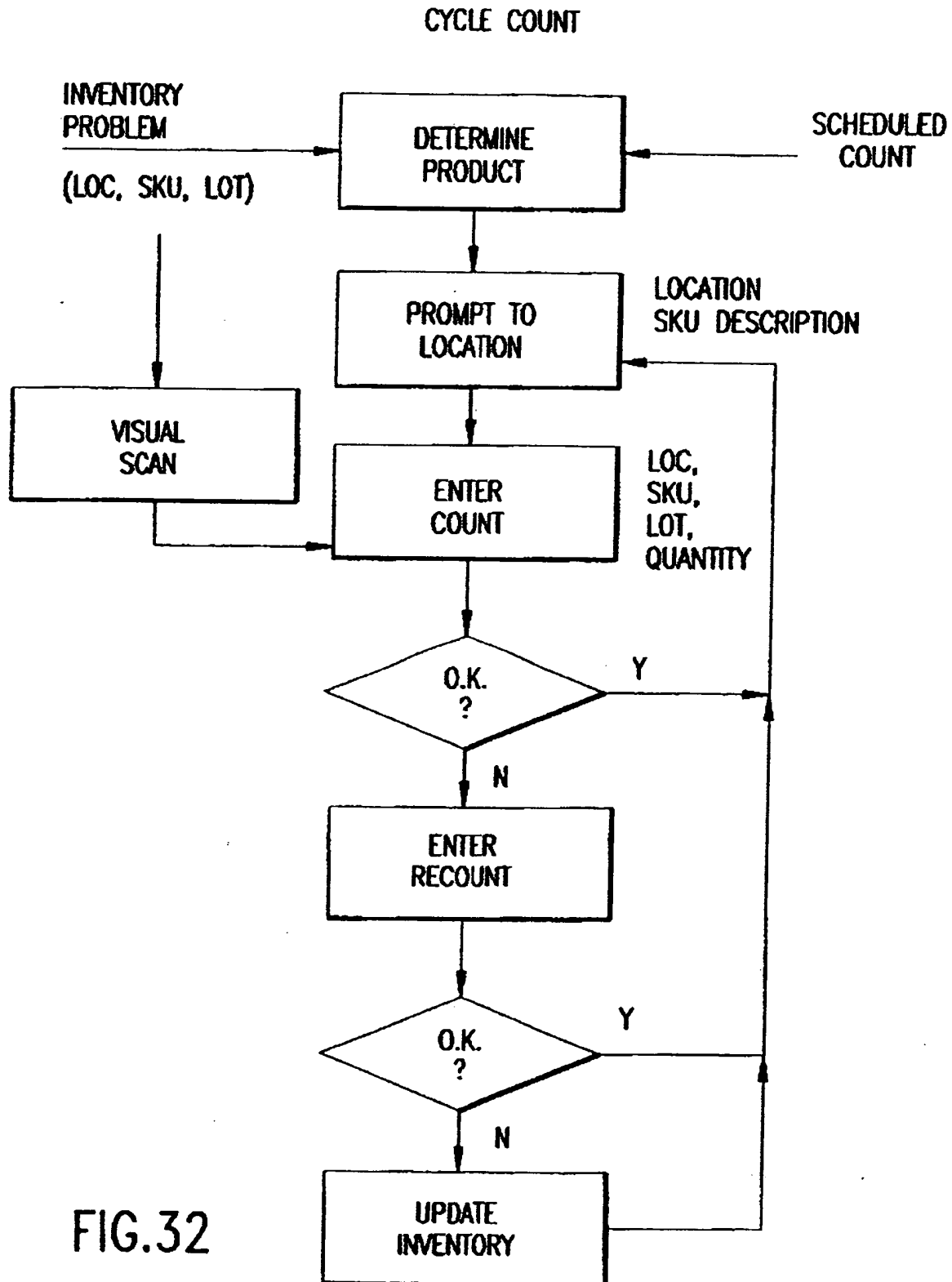

FIG.32

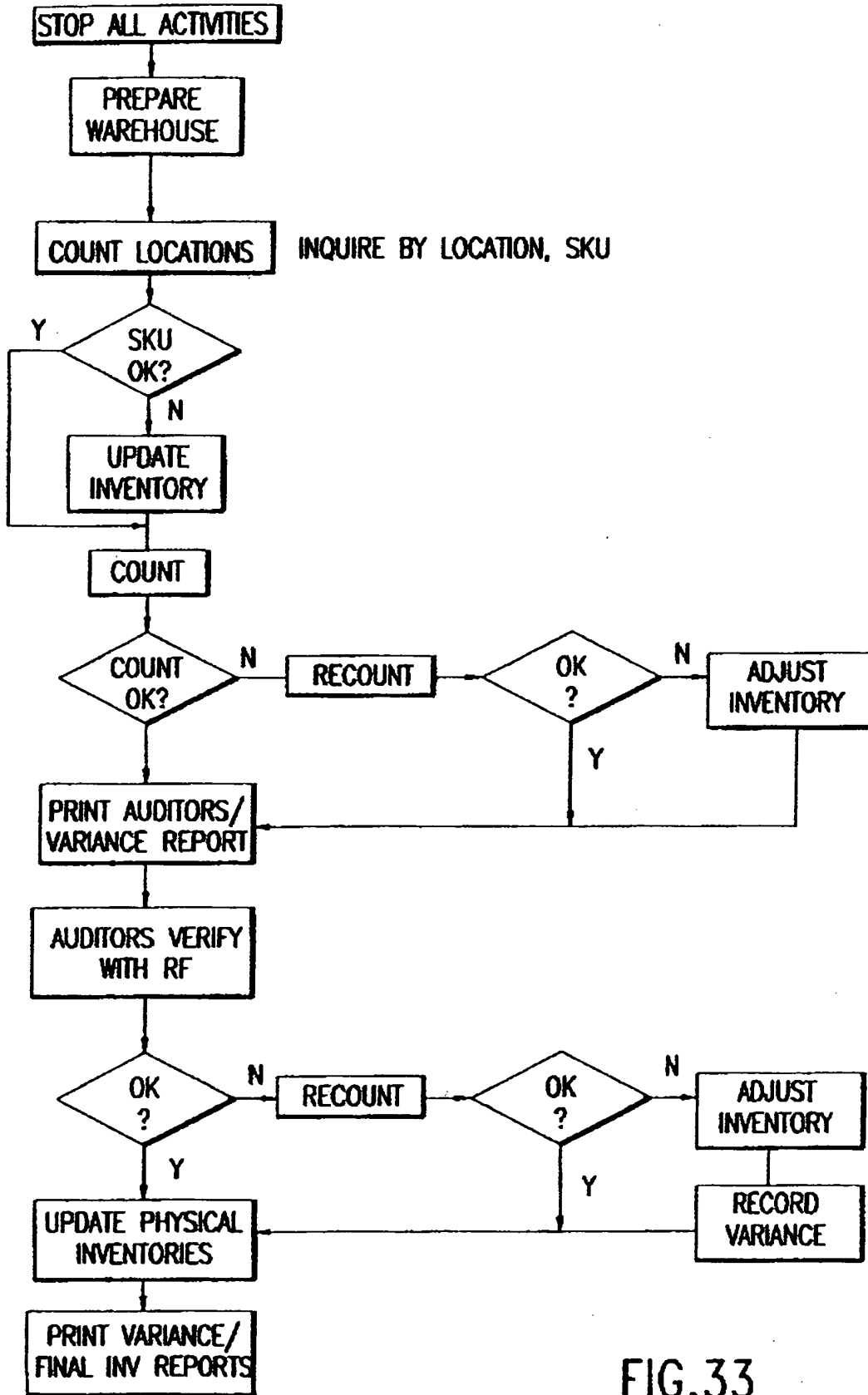

FIG.33

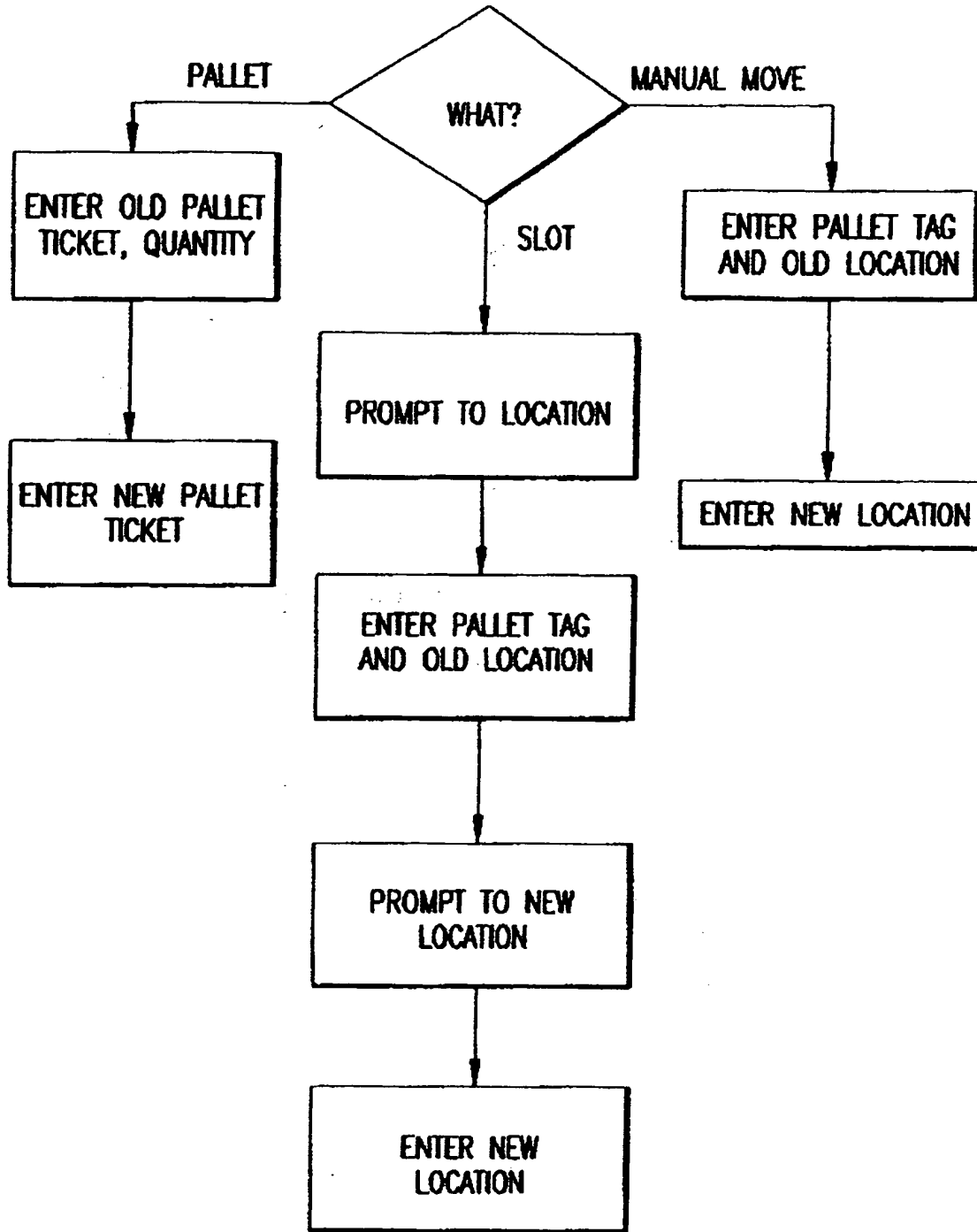
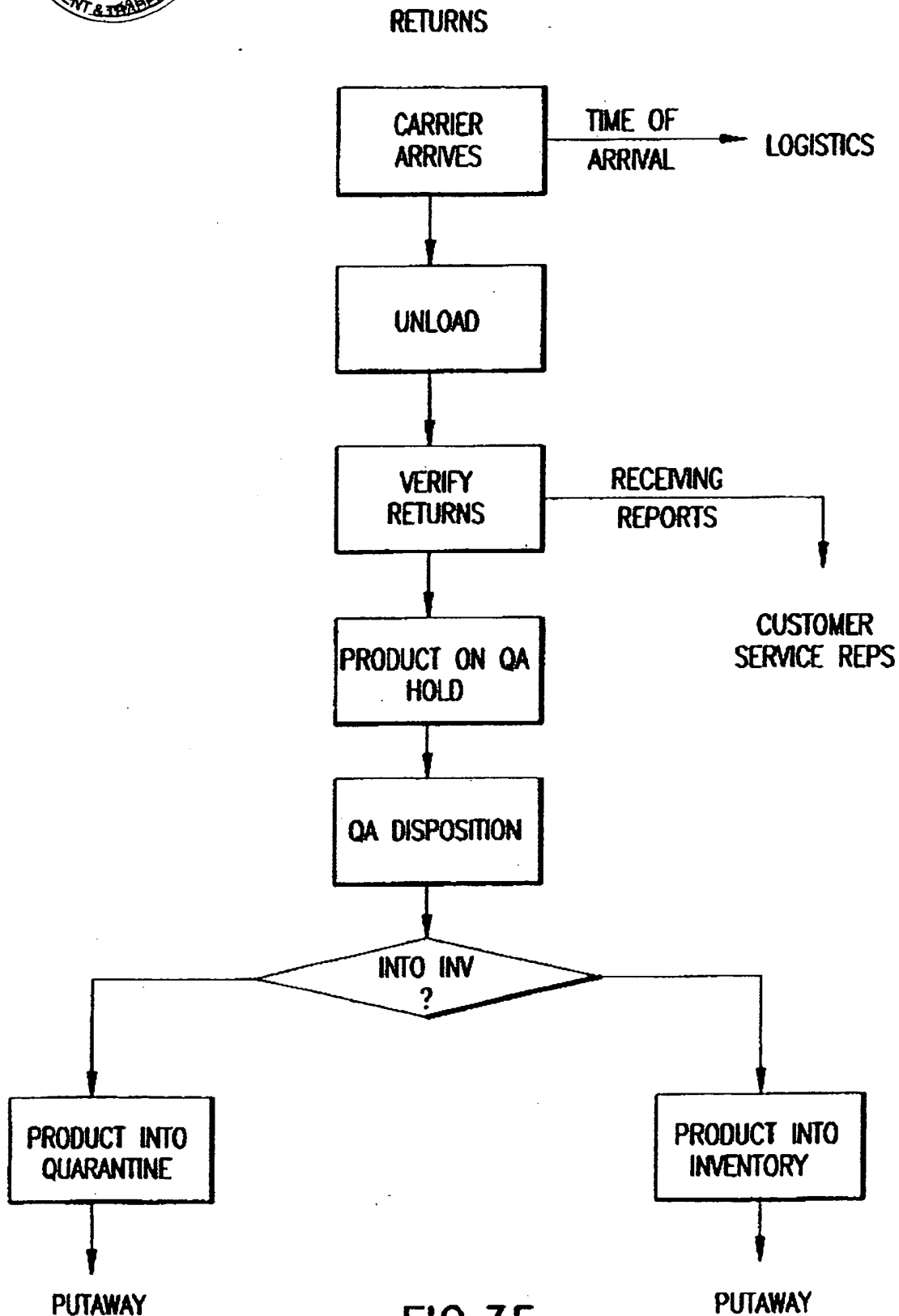

FIG.34



**FIG.35**

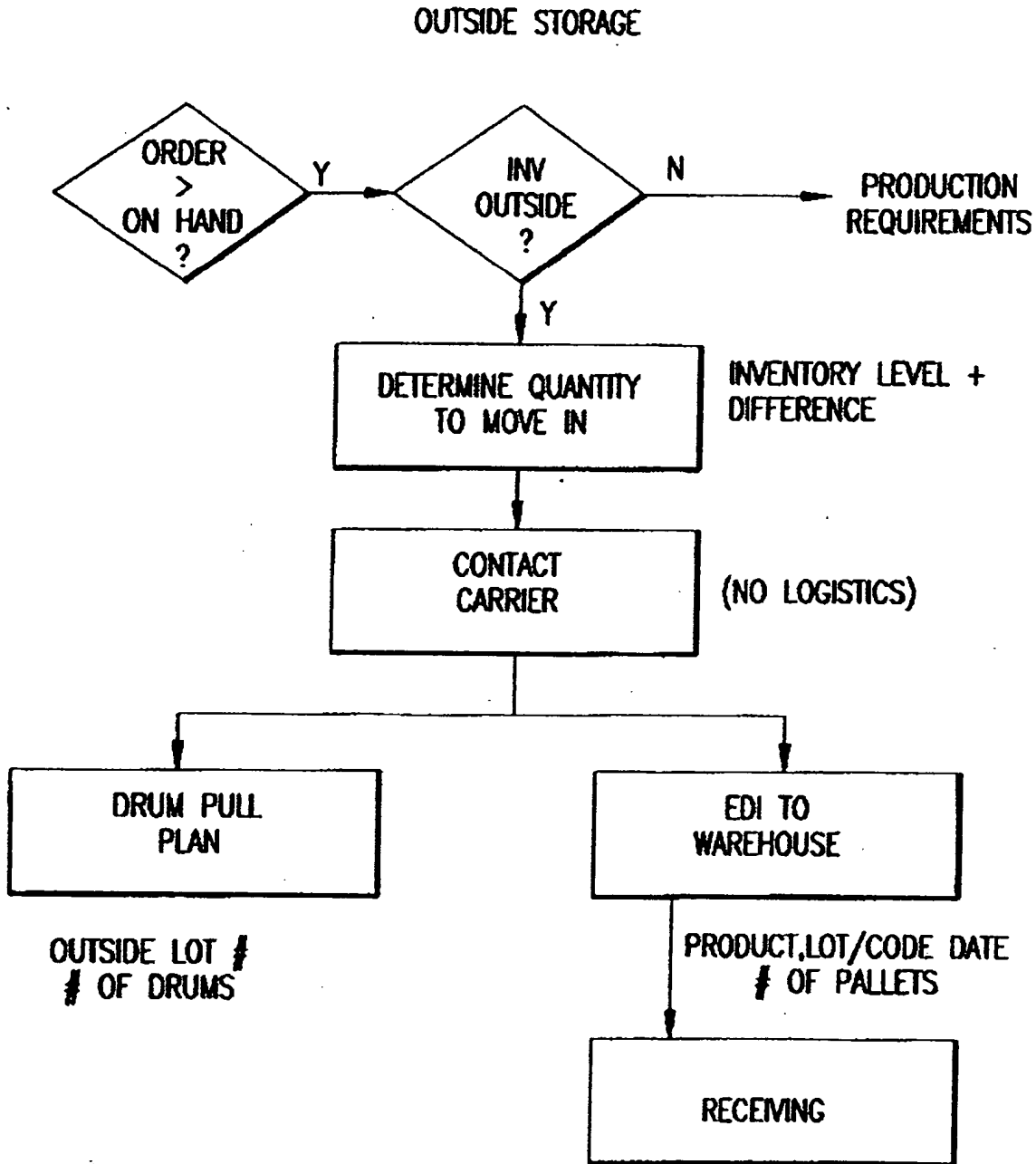

FIG.36

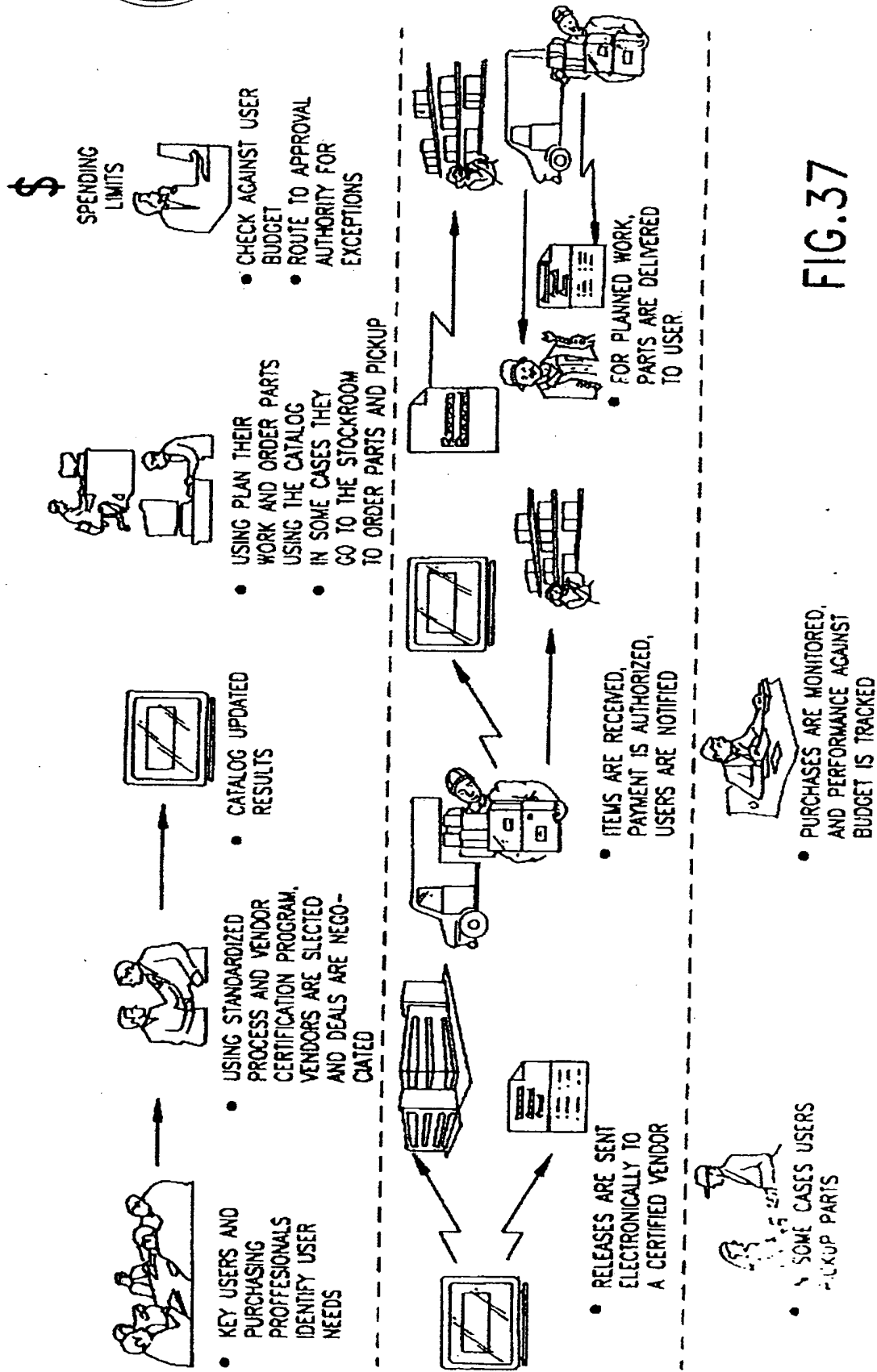
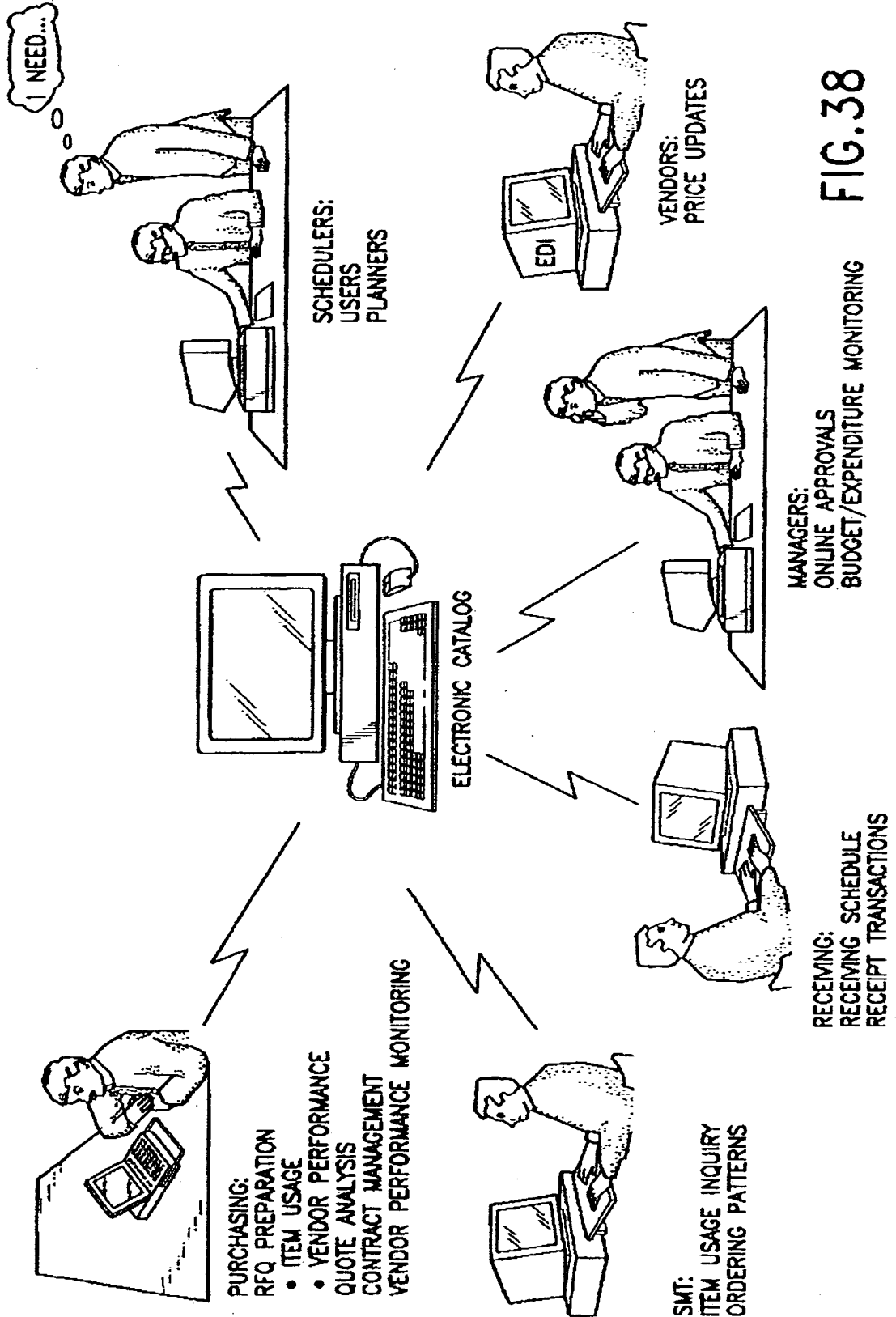

FIG.37



**FIG.38**



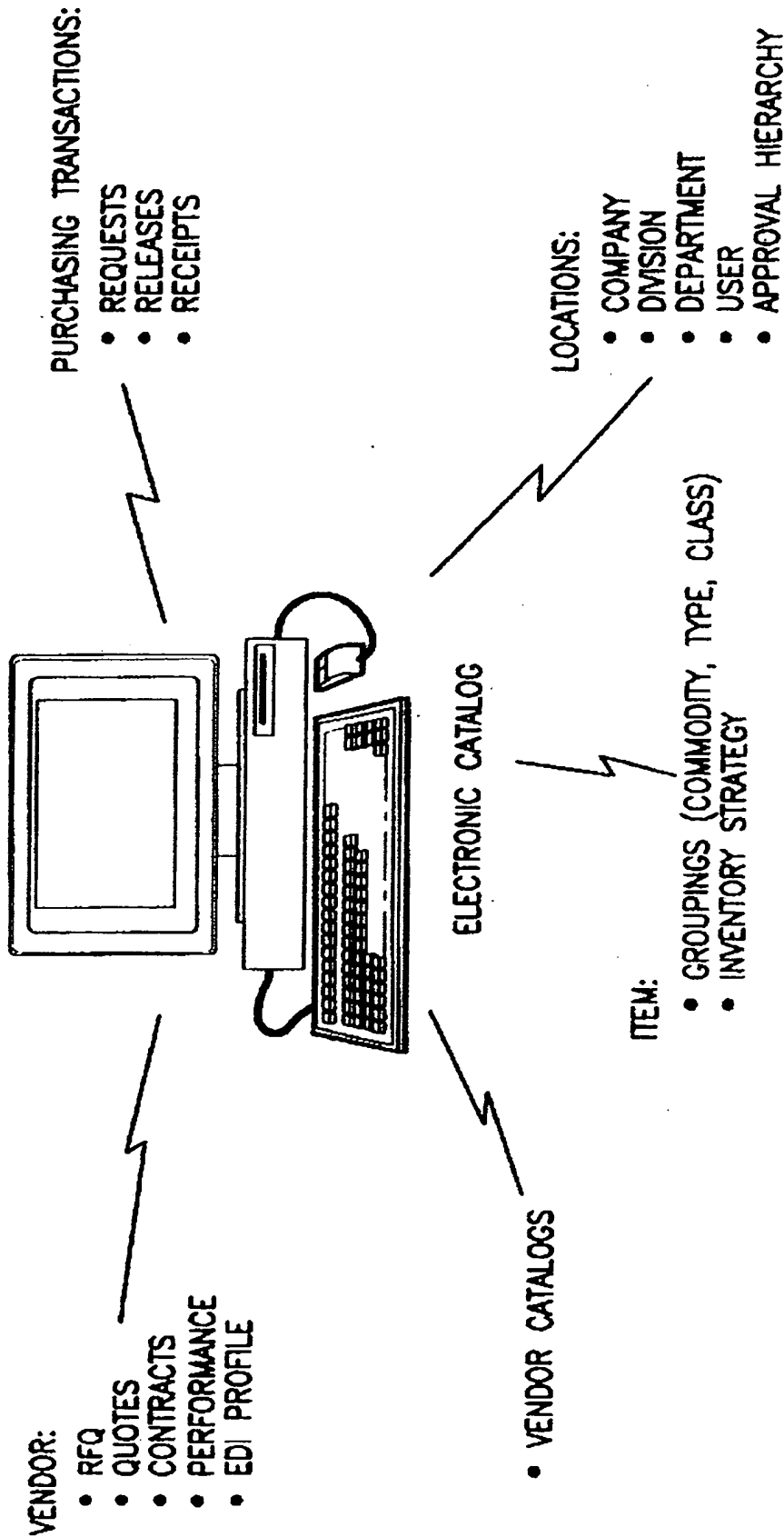

FIG.39

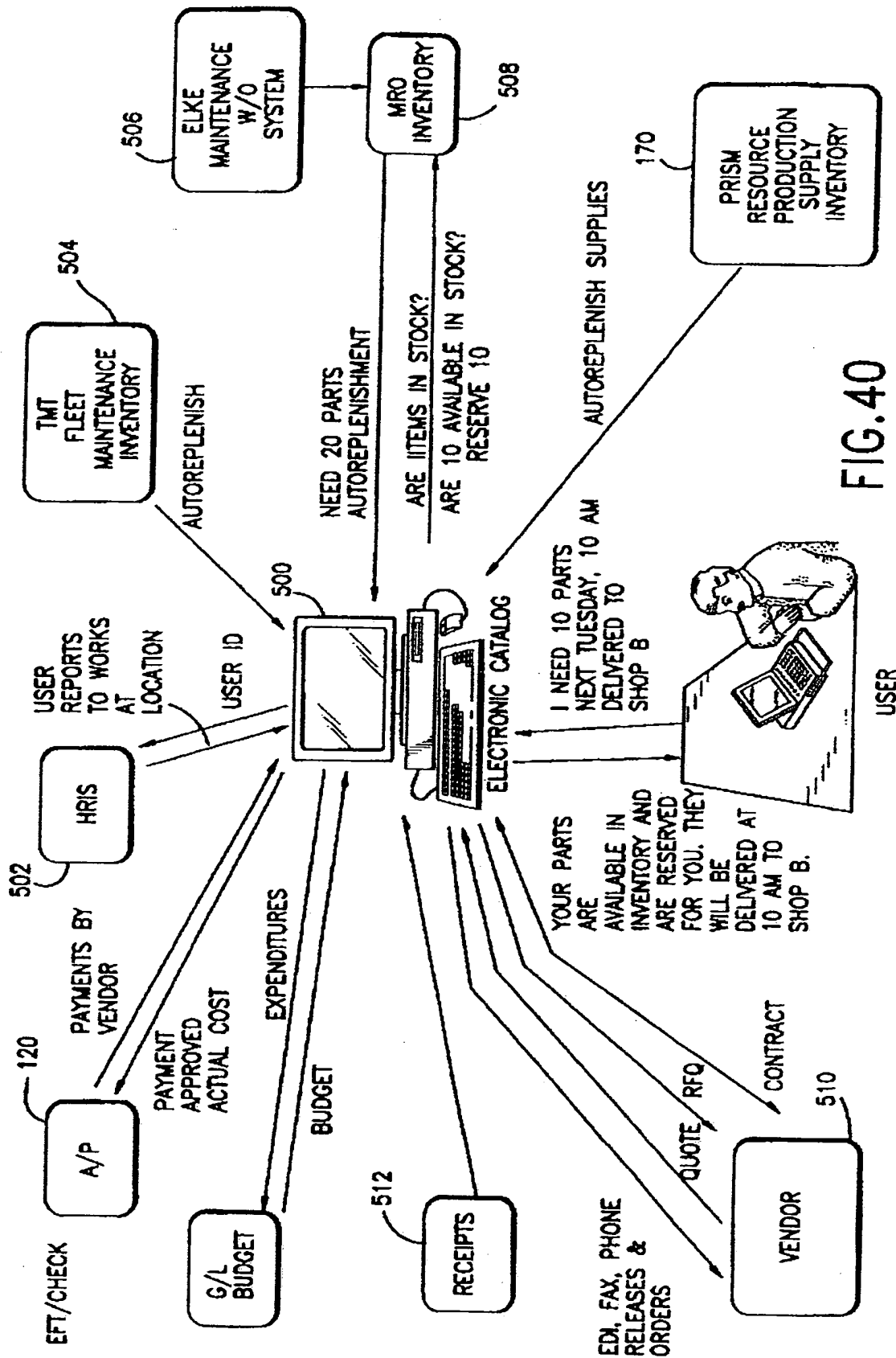

FIG. 40